

Numatic

TT 1840G HT 1840

SCRUBBER DRYER



Original Instructions

CAUTION, Read instructions before using the machine

GB

numatic.com

Machine Overview

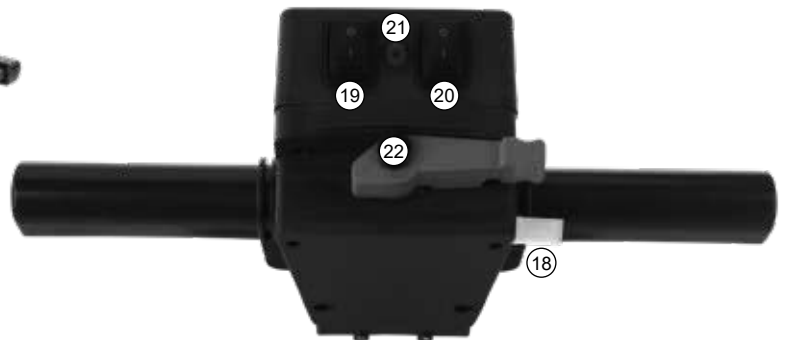
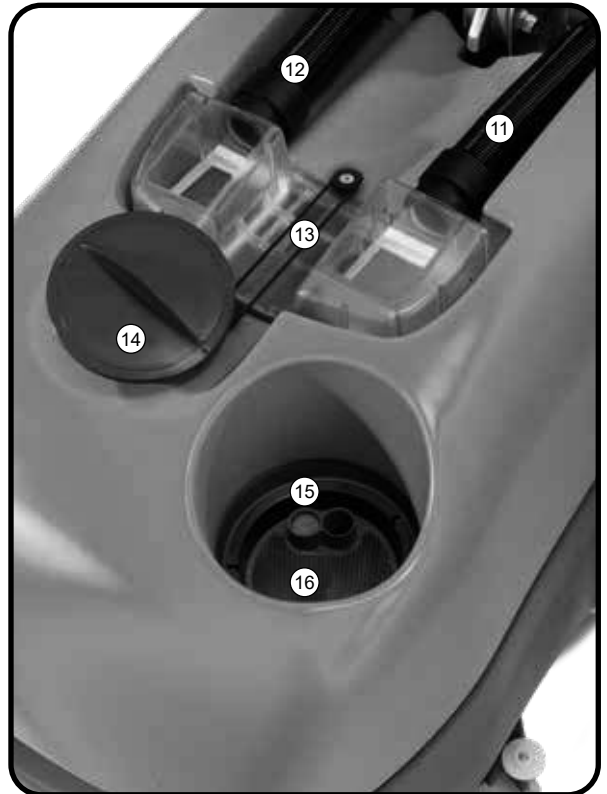

1	Operator control panel	12	Vacuum hose
2	On / Off Lever	13	Separator
3	Waste water tank	14	Clean-water filler cap
4	Clean water tank	15	Clean-water level indicator
5	Brush deck	16	Clean-water tank fill point
6	Squeegee blades	17	Top tank (waste water) drainage hose
7	Floor-tool retaining knobs	18	On / Off Switch
8	Clean-water on / off tap	19	Vacuum Switch
9	Clean-water emptying cap	20	Pump Switch
10	Rear moving wheels	21	Power Light
11	Floor-tool vacuum hose	22	Handle Position lever

Quick Set-Up Guide



Please read before commencing any operation.
After the removal of all the packaging, carefully open and check the contents.



Using the handle position lever, move the handle into the upright position. (Fig 1).

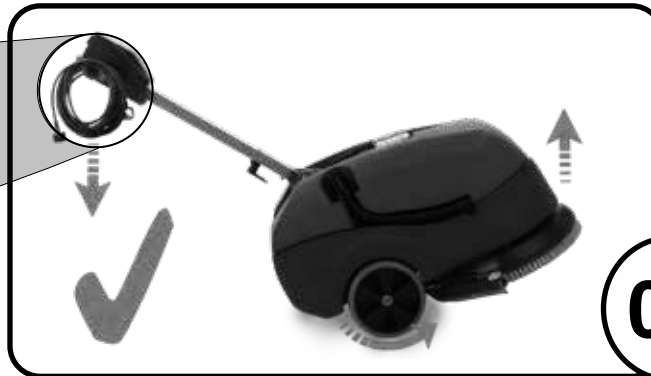
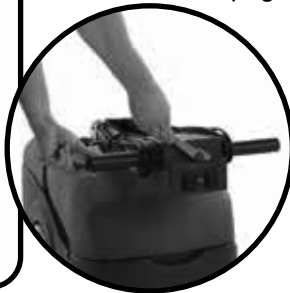

Tip the machine.
(see Page 4)



Fit the Brush / Pad (Fig 2).



Swing the floor tool carrier from behind the brush. (Fig 3).



Use the two locking knobs fitted to the floor tool, secure to the floor tool to the floor tool carrier. (Fig 4).



Fill using a hose, bucket or a suitable container. (Fig 5).

**Fill the clean-water tank to a Max of 18 litres
(see page 5)**

**For operation and cleaning controls
(see page 9)**

Machine Set-Up

Tipping the Machine

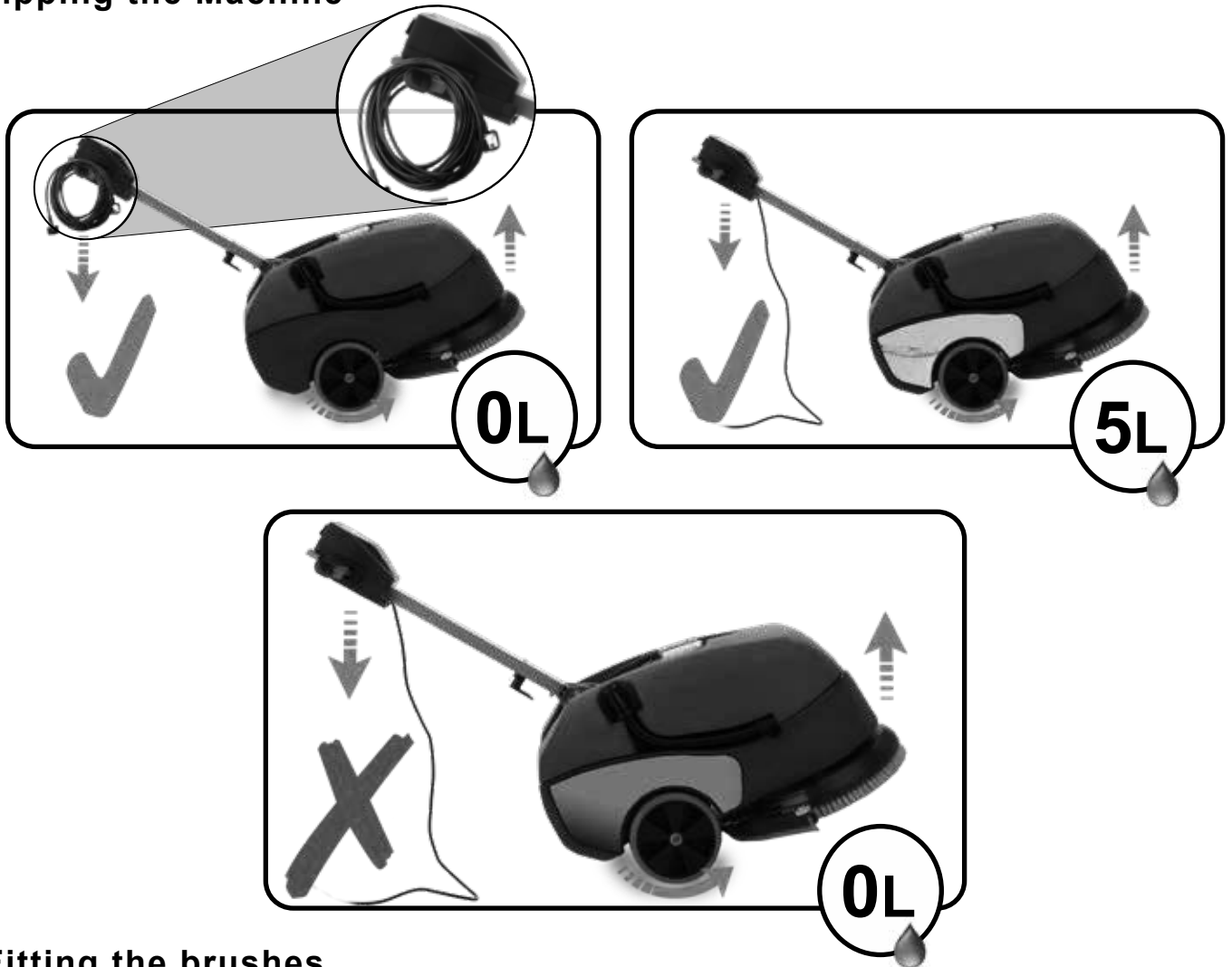

Fitting the brushes

Featuring the Nulock brush system.

The brush is fitted simply by pushing and twisting to lock in place, making fitting and removal a simple process.

Only use manufacturer supplied brushes.

This machine requires a 400mm brush or a 360mm pad.



Slide the brush / pad under the brush deck (Fig 6).



Fit the brush / pad onto the Nulock drive chuck, twist to lock the brush / pad in place (Fig 7).

Safety gloves are recommended for the changing of used brushes.

Machine Set-Up

Fitting the Floor Tool

The floor tool has been designed for quick fitting, allowing easy squeegee blade replacement and a safety knock-off feature if the floor tool gets snagged, whilst in transit.

Note: The lever moves upward and backward motion to lock the floortool in the raised position.



The floor tool carrier can be raised and locked from moving by operating the locking lever, upwards and backwards.

This lever can be found next to the lower section of the handle. Unlock and swing the floor tool carrier to the side of the machine (Fig 8).

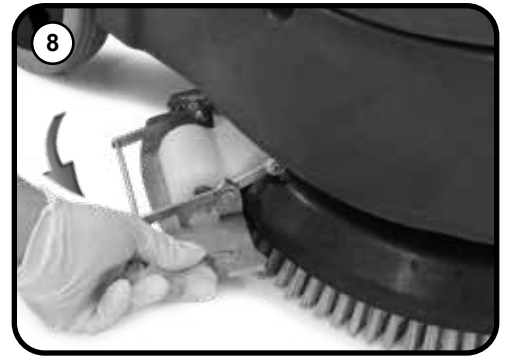

Note: It is easier to fit the floor-tool if the weight of the machine is resting on the brush. Ensure the brush is fitted first.



Secure to the carrier using the two knobs fitted to the floor tool carrier (Fig 9) - (Fig 9a).

Do not over tighten the retaining knobs.



Filling the clean-water tank



The HT1840 & TT1840 are equipped with a large 18 litre clean water tank allowing large areas to be cleaning in a single fill.

To fill the clean water tank, remove the filler cap (Fig 10).

Fill using a hose, bucket or a suitable container. (Fig 11).



Note: Great care must be taken to ensure that contaminants (leaves, hair, dirt, etc) are not allowed to enter the clean-water tank during the filling process. If using a bucket or similar, ensure it is always clean and free from debris.

Machine Set-Up

Fill Level Indicator

Fill the clean water tank to a maximum of 18 litres, including cleaning chemicals if required. Follow chemical manufacturing guide lines.

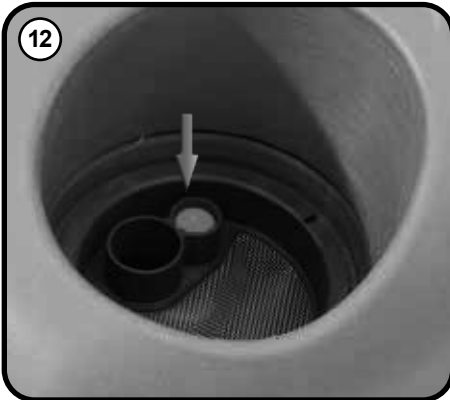

Use the fill indicator (Fig 12).

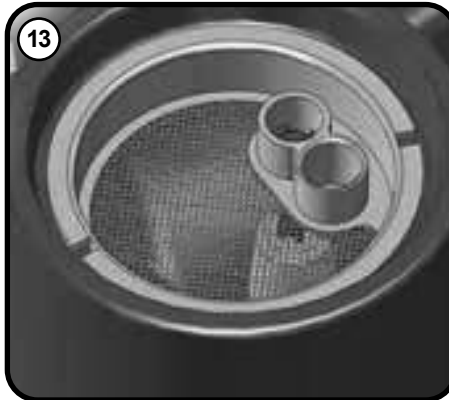

Showing the clean water tank empty (Fig 13).

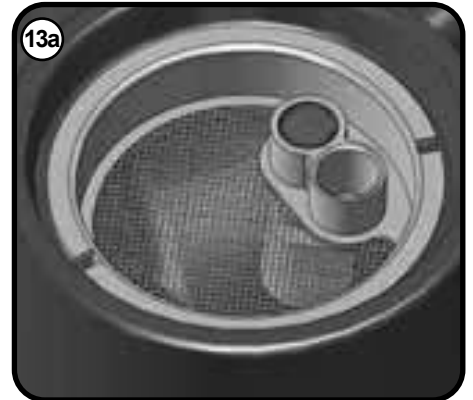

Showing the clean water tank full (Fig 13a).

WHEN HANDLING AND MIXING CHEMICALS

Always ensure that chemical manufacturer's safety guidelines are followed. Only use chemicals recommended for use in auto scrubber-dryers.

Control of Substances Hazardous to Health (COSHH)

For best results use a non-foaming type of chemical, dilute to the manufacturer's specification. For further guidance on hazardous substances refer to health and safety instructions online. Visit <http://www.hse.gov.uk/> for UK information.



Water Flow Adjustment

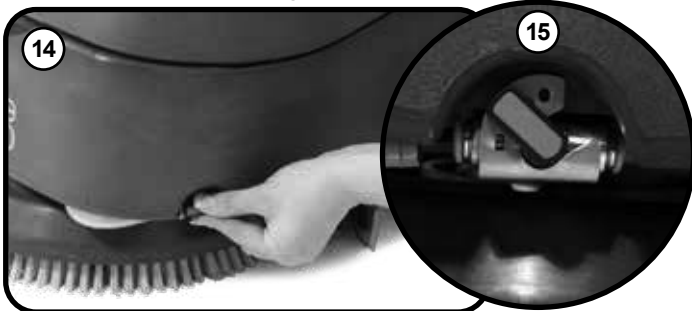

Located on the left of the machine is the On / Off water tap (Fig 14 / 15).

Pre-cleaning advice.

Before performing the cleaning operation, place out appropriate warning signs and sweep or dust-mop the floor (Fig 16).



Numatic part (629044) Wet Floor sign (available if required)



Important
Do not operate machine unless the Operator Manual has been read and fully understood.



Machine Set-Up



CAUTION
When moving or lifting the HT 1840 / TT 1840, follow the national safety guidelines on lifting.



Moving the machine

17



Transport the machine by tilting back on to the main transit wheels (Fig 17).

18



When the top tank (waste water) is full the machine can be tilted to a maximum of 10° for transporting to dumping area (Fig 18).

19



When the bottom tank (clean water) is full the machine can be tilted to a maximum of 45° (Fig 19).

20



Weight of empty machine 38.5Kg (85 lbs) (Fig 20).



CAUTION
Ensure both tanks are empty before attempting to lift the machine.



Machine Operation

Pre-scrub mode

The HT1840 & TT1840 have been designed to cope with a variety of floor types and different levels of soiling. On heavily soiled floors use a 'double scrub' technique.

First pre-scrub the floor with the floor tool in the raised position (Fig 21), allow the chemical time to work, then scrub the area a second time with the floor tool lowered.

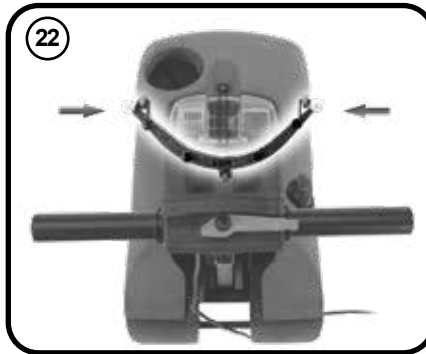
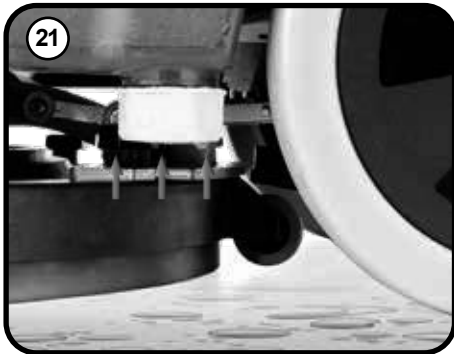

To raise the floor-tool, ensure the floor tool carrier is central to the machine (Fig 22). Lift the lever near the base of the handle and lock into position (Fig 23).

Note: The lever moves upward and backward motion to lock the floor tool in the raised position.

Floor tool in use

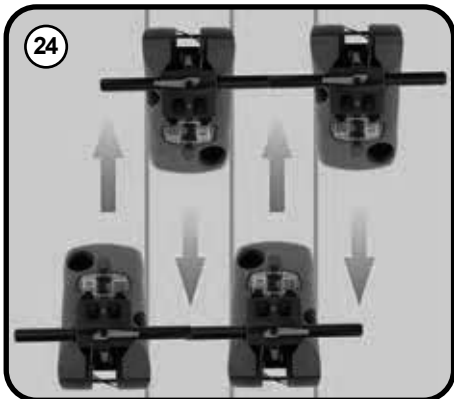

The clean-water / chemical mix is dispersed via 'THRU-FEED' system. The waste water is then retrieved by the floor tool

Overlap the scrubbing path by 10cm to ensure an even clean (Fig 24).

If streaking occurs, wipe the floor tool blades clean (Fig 25).



Note: Care must be taken to reduce speed when cornering or when manoeuvring around obstacles.

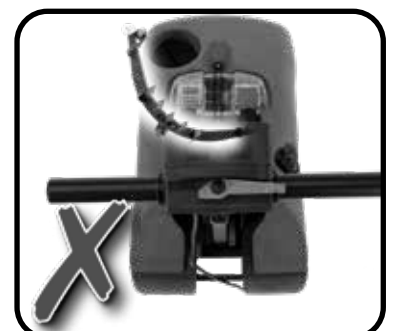
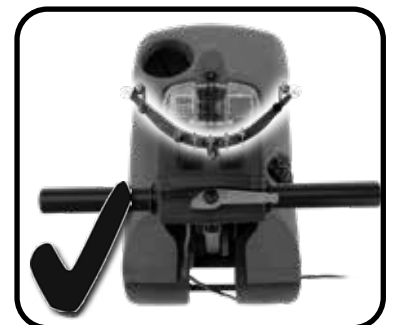

Setting the cleaning controls

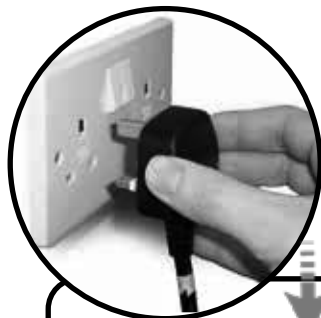

Ensure your HT1840 / TT1840 machine has been plugged into a suitable power supply.
Select the desired function using the ON / OFF switches fitted to the handle.

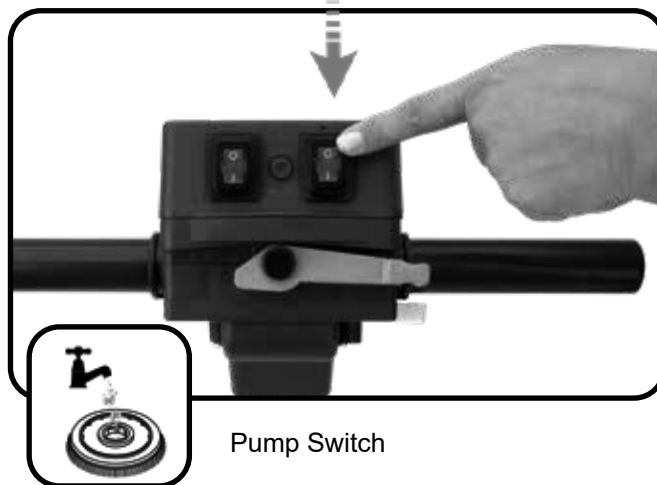
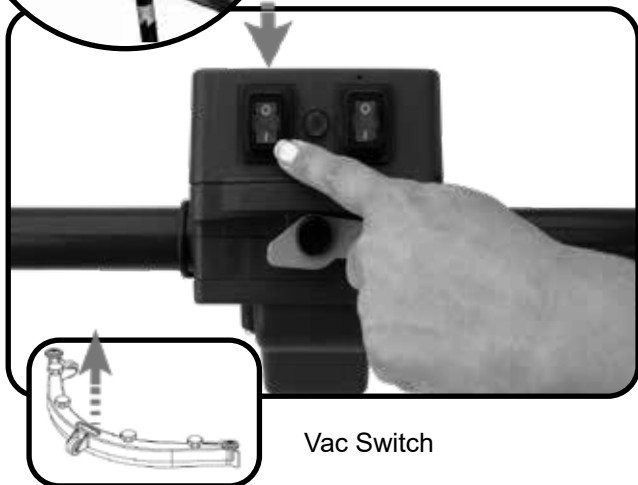

Note: The Pump Switch will only function when the Brush is in operation.

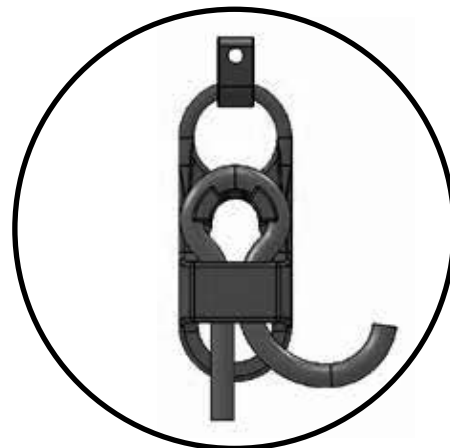
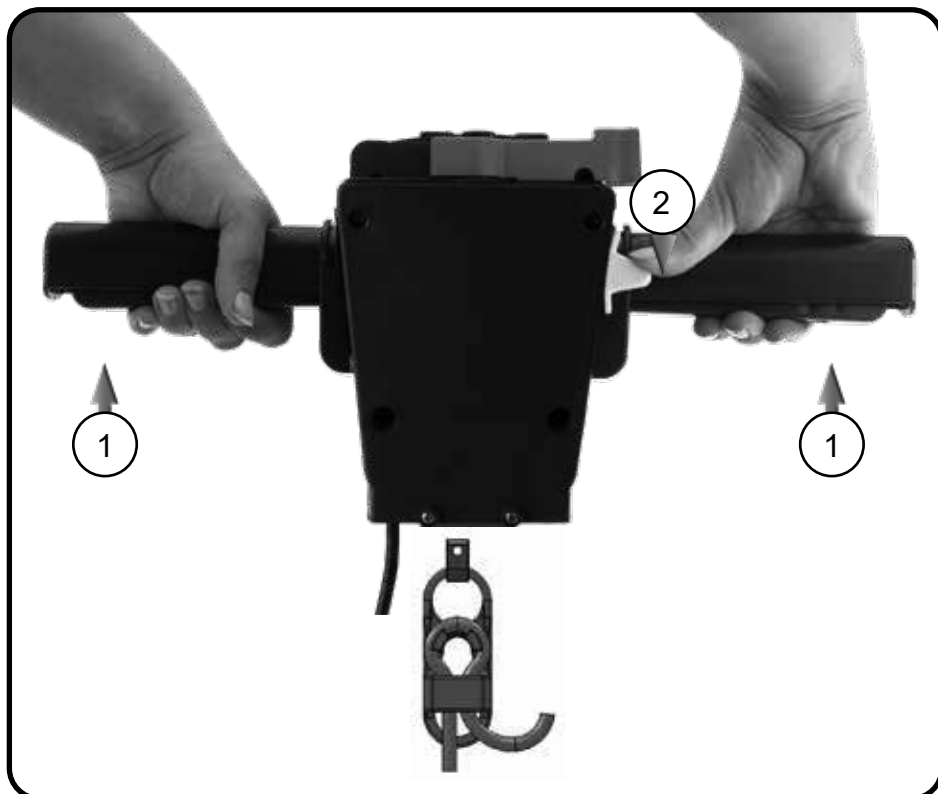

To start: hold down either trigger and press the yellow start button once

Regular Maintenance



**ALWAYS ENSURE THAT THE POWER SUPPLY IS DISCONNECTED,
PRIOR TO ANY MAINTENANCE OPERATION.**



The HT1840 & TT1840 have been designed with ease of use in mind, this included easy stripping down and cleaning.



After use, empty waste water tank using emptying hose and flush out with clean water. **A**

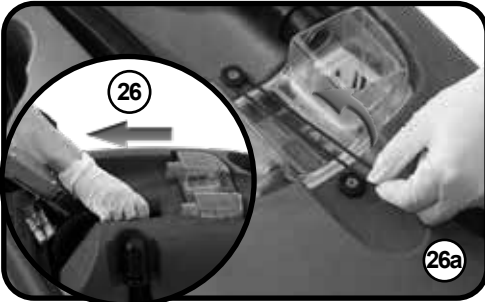

Remove the two hoses and disconnect the separator from the machine (Fig 26). Undo the separator restraining strap (Fig 26a) and lift off the separator. The separator has a sealing rubber which should be examined at every clean down (Fig 27). Rinse using clean water.

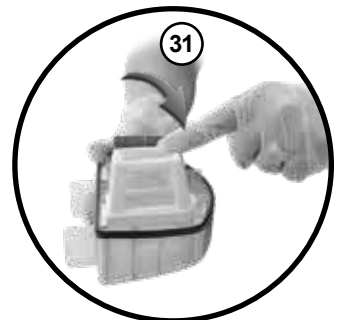

Remove the two filters clipped into the separator and flush with clean water (Fig 28)(Fig 29). Replace by fitting the rear of the filter first then clipping the front to lock in place (Fig 30) (Fig 31).



Once emptied the top waste water tank can simply be lifted off. (Fig 32).

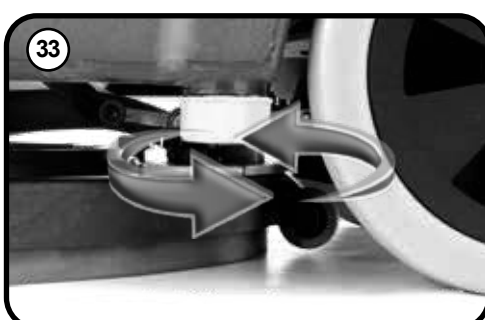

The clean water tank can be drained via the yellow cap fitted to the left hand side of the machine. The cap has a rubber seal and might require a spanner to remove. (Fig 33).

Note:
Avoid over tightening the clean water draining cap.

Regular Maintenance

Clean Water Filter

Inside the clean water tank is a filter, located below the clean water inlet. Remove the cap and large debris basket.

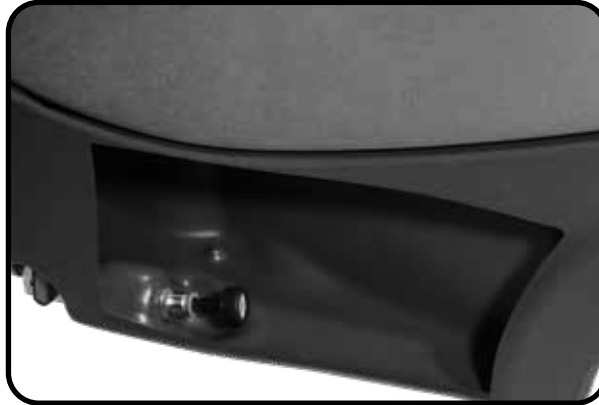

***NOTE:** Clean water tank side cut away for clarity.

Make sure this filter is kept clean from debris and chemical contamination.

Replacing the Waste Water Tank



Refit the separator and reconnect the vacuum and suction hose (Fig 36).

Refit the separator restraining strap (Fig 37).

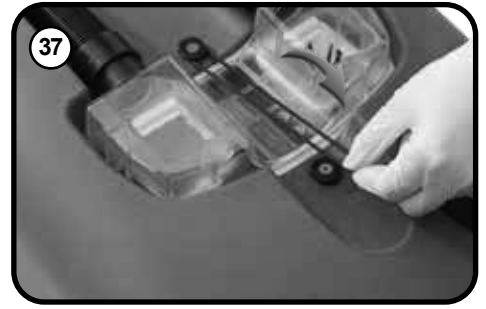

Notes:

Changing the Floor-Tool Blades



ALWAYS ENSURE THAT THE POWER SUPPLY IS DISCONNECTED PRIOR TO ANY MAINTENANCE.



To change the floor tool, firstly swing the floor tool clear of the machine (Fig 38).



Undo the two floor tool retaining knobs (Fig 39).

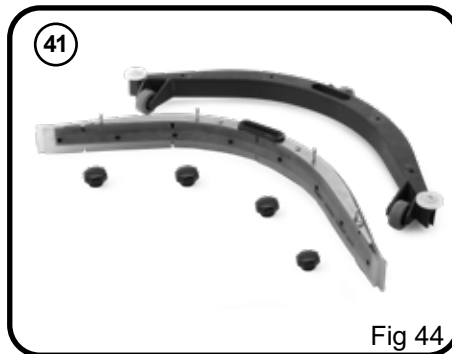

Fig 44

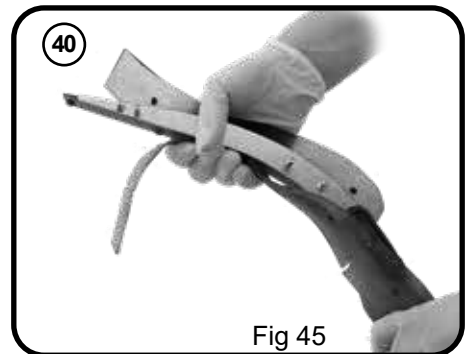

Fig 45

Unscrew the four knobs securing the blade holder (Fig 40).

Remove the blade holder (Fig 41).

Replace the Squeegee blades using (606261) replacement blade set (Fig 42), fitting the blades on to the moulded location lugs.

Refitting the Floor Tool Blades

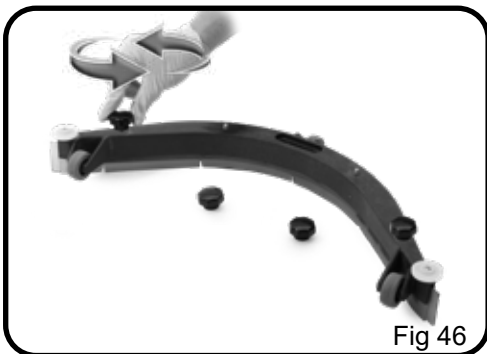

Fig 46

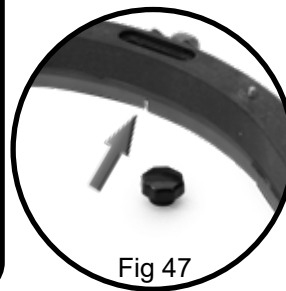

Fig 47

Refit the blade holder, retain using the two outer knobs (Fig 46)

Ensure the slotted blade goes to the front of the floor tool (Fig 47).

Note:
The blades are designed to be reversible, thus extending their useful working life.

Refit the floor tool using the two central knobs to the floor tool.

Refer to Page 5 for fitting instructions.

1. Floor tool main body
2. Blade carrier
3. Rear blade
4. Front blade (slotted)
5. Retaining Knobs x 4



Use Genuine NUMATIC spare parts, use Replacement Blade Set (606261)

About the Machine

Rating Label

- ① Company Name & Address
- ② Machine Description
- ③ Voltage Frequency
- ④ Power rating
- ⑤ Max Gradient
- ⑥ Weight (ready to use)
- ⑦ Approvals Mark
- ⑧ WEEE Logo
- ⑨ Splash Proof Rating
- ⑩ Machine yr/wk Serial number

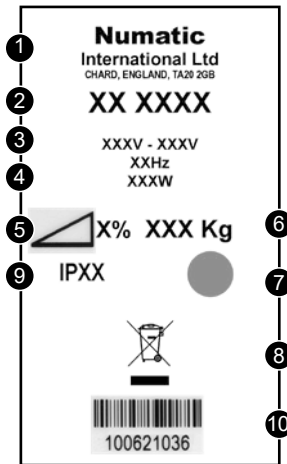

Safety Critical Component

Mains lead:
H05VV-F 20m x 1.0 mm² x 3 core

WEEE (Waste, Electrical and Electronic Equipment)

Scrubber dryer Accessories and packaging should be sorted for environmentally- friendly recycling.

Only for EU countries.

Do not dispose of scrubber-dryer into household waste.

According to the European Directive 2002/96/EC on waste electrical electronic equipment and its incorporation into national law.

Scrubber-dryers that are no longer suitable for use must be separated, collected and sent for recovery in an environmentally- friendly manner.



PPE (Personal protective equipment) that may be required for certain operations).

Ear Protection	Safety Footwear	Head Protection	Safety Gloves	
Dust/Allergens Protection	Eye Protection	Protective Clothing	Hi-Vis Jacket	Caution wet floor sign

Note:

A risk assessment should be conducted to determine which PPE should be worn.

Daily

- Keep the machine clean
- Ensure brushes/ pads/ squeegee/ filters are in good condition
- Check for any worn or damaged parts and replace immediately
- Drain and rinse dirty water tank after every use
- Store machine with brush deck secured in tilted position

Weekly – as daily and –

- Check brush or pad and skirt and rinse
- Check floor tool blades for wear and wipe clean
- Clean separator assembly including filter and check condition of seal
- Flush out system with clean water and clean filters
- Do not steam clean or pressure wash

Twin Tec
Maintenance

Information for Scrubber Dryer



ORIGINAL INSTRUCTIONS
READ MANUAL BEFORE USE

Component	Interval	Inspect for
Mains Lead	DAILY	Scuffing, cracks, splits, conductors showing
Brushes	DAILY	Bristle damage, wear, drive collar wear
Squeegee Blade	BEFORE EACH USE	Wear, cracks, splits
Filters	BEFORE EACH USE	Clogging and debris retention
Tanks	AFTER EACH USE	Rinse dirty water tank after use



As with all electrical equipment care and attention must be exercised at all times during its use, in addition to ensuring that routine and preventative maintenance is carried out periodically in order to ensure its safe operation.

Failure to carry out maintenance as necessary, including the replacement of parts to the correct standard could render this equipment unsafe and the manufacturer can accept no responsibility or liability in this respect.

When ordering spare parts always quote the Model Number / Serial Number specified on the Rating Plate.

This appliance is not intended for use by persons (including children) with reduced physical, sensory or mental capabilities, or lack of experience and knowledge, unless they have been given supervision or instruction concerning use of the appliance by a person responsible for their safety.

Children should be supervised to ensure that they do not play with the appliance.

This machine is not suitable for picking-up hazardous dust.



Do not use on surfaces having a gradient exceeding that marked on the appliance.

The machine is not to be stored outdoors in wet conditions.

This machine is for indoor use only.

Read the instruction manual before using the appliance.

This product meets the requirements of IEC 60335-2-72

NOTES

This machine is also suitable for commercial use, for example in hotels, schools, hospitals, factories, shops and offices for other than normal housekeeping purposes.



DO

- Ensure only competent persons unpack/assemble the machine.
- Keep your machine clean.
- Keep your brushes in good condition.
- Replace any worn or damaged parts immediately.
- Regularly examine the power cord for damage, such as cracking or ageing. If damage is found, replace the cord before further use.
- Only replace the power cord with the correct Numatic approved replacement parts.
- Ensure that the work area is clear of obstructions and / or people.
- Ensure that the working area is well illuminated.
- Pre-sweep the area to be cleaned.



DON'T

- Use steam cleaners or pressure washers to clean the machine or use in the rain.
- Attempt machine maintenance or cleaning unless the power plug has been removed from the supply outlet.
- Allow any inexperienced repairs. Call the experts.
- Strain cable or try to unplug by pulling on cable.
- Leave the brush pad on the machine when not in use.
- Allow the machine to be used by inexperienced or unauthorised operators or without appropriate training.
- Use the machine without the solution tanks properly positioned on the machine, as shown in the instructions.
- Expect the machine to provide trouble-free, reliable operation unless maintained correctly.
- Lift or pull the machine by any of the operating triggers - Use the main handle.
- Remove the handle from the machine except for service and repair.
- Use on surfaces having a gradient exceeding that marked on the machine.



Only use brushes provided with the appliance or those specified in the instruction manual. The use of other brushes may impair safety.

A full range of brushes and accessories are available for this product.

Only use brushes or pads which are suitable for the correct operation of the machine for the specific task being performed.

It is essential that this equipment is correctly assembled and operated in accordance with current safety regulations. When using the equipment always ensure that all necessary precautions are taken to guarantee the safety of the operator and any other persons who may be affected.

Wear non-slip footwear when scrubbing. Use a respiratory mask in dusty environments.

When cleaning, servicing or maintaining the machine, replacing parts or converting to another function the power source shall be switched off.

Mains operated machines shall be disconnected by removing the power plug, and battery operated machines shall be disconnected by switching off the isolating key.

Machines left unattended shall be secured against unintentional movement. Operators shall be adequately instructed as to the correct use of the machine.

When detergents or other liquids are used, read the manufacturer's instructions. Do not allow the supply cord to come into contact with the rotating brushes.

When detergents or other liquids are used, read the manufacturer's instructions. Do not allow the supply cord to come into contact with the rotating brushes.

Data

<i>Brush Motor</i>	<i>Vac Motor</i>	<i>Power</i>	<i>Noise</i>	<i>Speed</i>	<i>Brush</i>	<i>Dimensions</i>
400 W	300 W	220-240v 50/60 Hz 115v 50Hz	71 dB(A)	50Hz = 150rpm	400 mm	Width - 520 mm Length - 880 mm Height - 1132 mm
<i>Gross Weight Full</i>	<i>Protection Class</i>	<i>Hand Arm Vibration</i>	<i>Pad</i>	<i>Net Weight</i>	<i>Cleaning Range</i>	<i>Water Capacity</i>
56.5 kg	IPX 4	1.4 +/- 0.06ms ²	360 mm	38.5 kg	42 m	18 L
<i>Fluid Flow tap @40°</i>	<i>Brush / Pad Pressure</i>	<i>Cleaning Speed</i>				
0.35 LPM	27.4 / 26.2 G/ cm ²	0-4.2 Kph				

Trouble-Shooting

PROBLEM	CAUSE	SOLUTION
Poor water pick-up	Waste-water tank full Clogged / blocked vacuum hose Loose hose connections Debris basket filter clogged/blocked Separator filter clogged / blocked Poor separator seal Damaged separator seal Damaged / split vacuum hose Damaged floor-tool blades	Empty waste-water tank Remove and clean Push tight connections Remove and clean Remove and clean Clean and refit Renew (contact service dept) Renew (contact service dept) Renew (contact service dept)
No brush / scrub function	No brushes fitted	Check and fit
Little or no water flow	Clean-water tank empty Clean-water tank filter blocked/ clogged	Fill clean-water tank Remove and clean

Failure to rectify the problem or in the event of a breakdown contact your Numatic dealer or the Numatic Technical help line +44 (0)1460 269268

Spare Parts

606261	HT1840 & TT 1840 Replacement Blade set	237411	HT1840 & TT1840 Grit Basket
237466	Skid Plate	237232	HT1840 & TT1840 Separator Filter
237268	Filler Cap Lid	303985	HT1840 & TT1840 Filler Cap Assembly
208448	Tank Drain Cap	303961	Clean Tank Filter Assembly (Inside)
208455	M5 Knob (Black)	303997	HT1840 & TT1840 dump Hose Assembly
208471	Constant Tension Clip (Dump Hose)	213055	HT1840 & TT1840 Vac Hose
208537	Constant Tension Clip (Vac Hose)	231054	HT1840 & TT1840 Suction hose



Notes:

HT 1840 TT 1840 220v ~ 240V ~ 115V

DRW - 13476 (A01) 19/03/2013

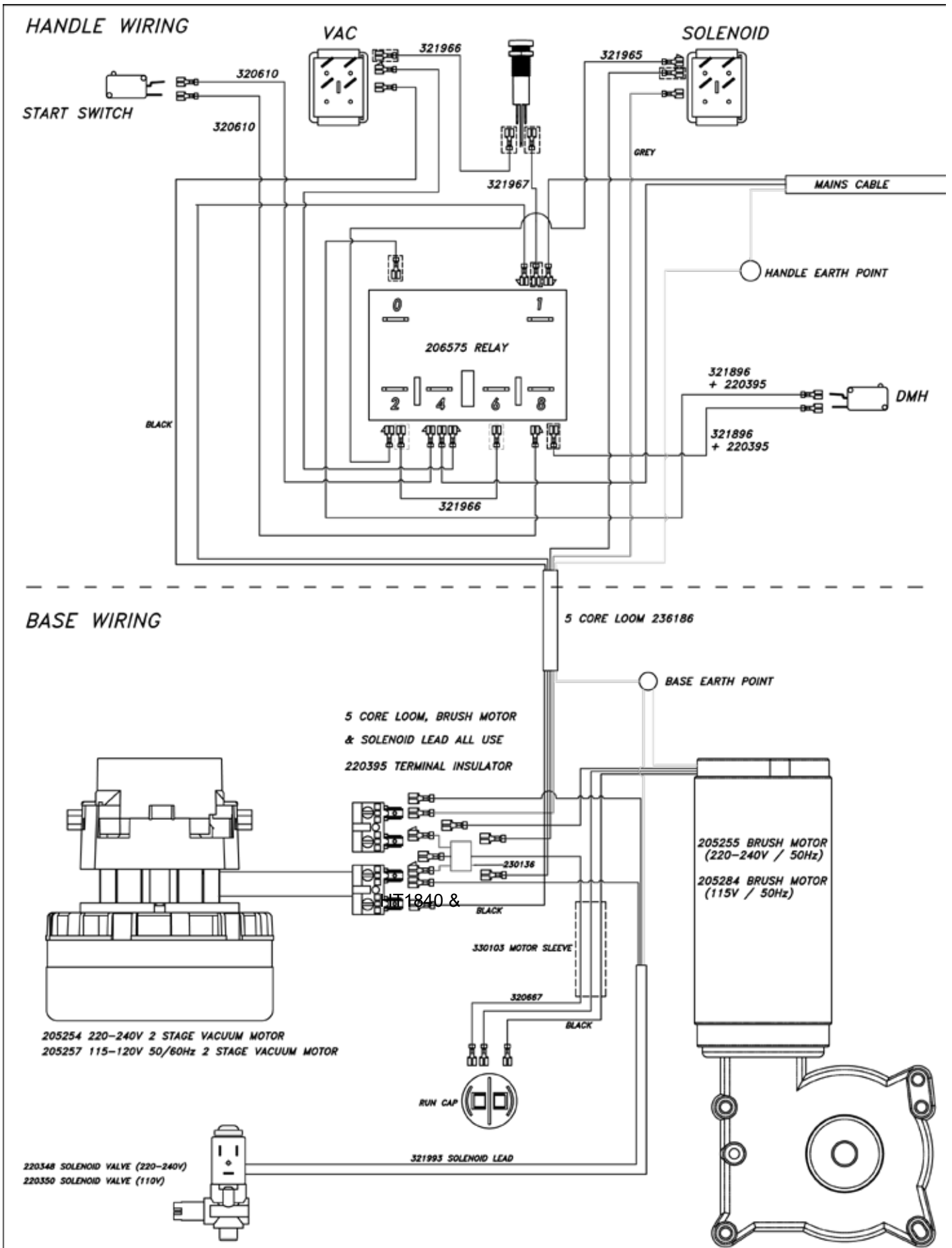

HT1840 Face Fitting Instructions

1

FRONT

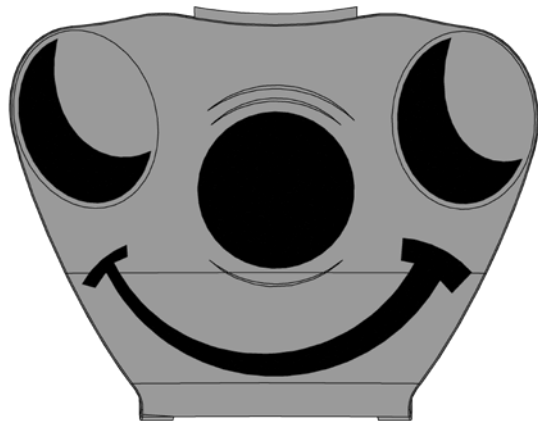

BACK

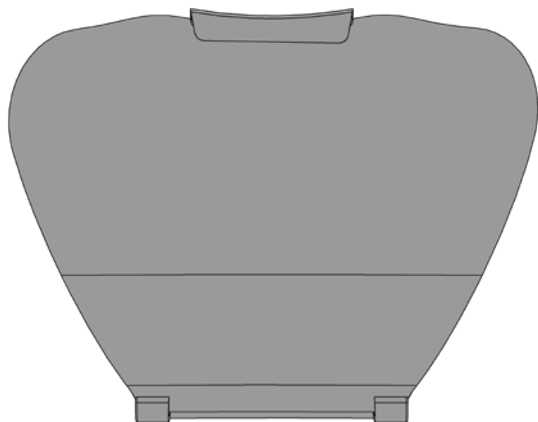

2

TOP CLIP

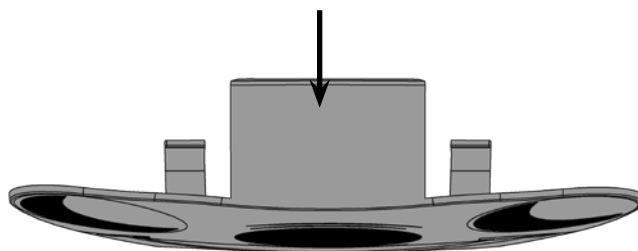

BOTTOM CLIPS

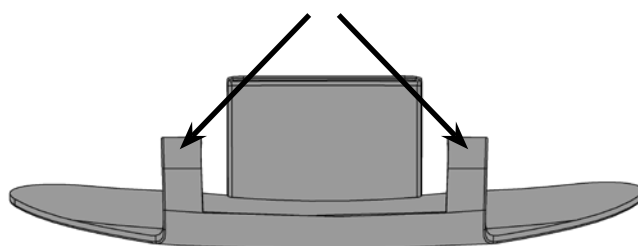

3

TOP CLIP LOCATION

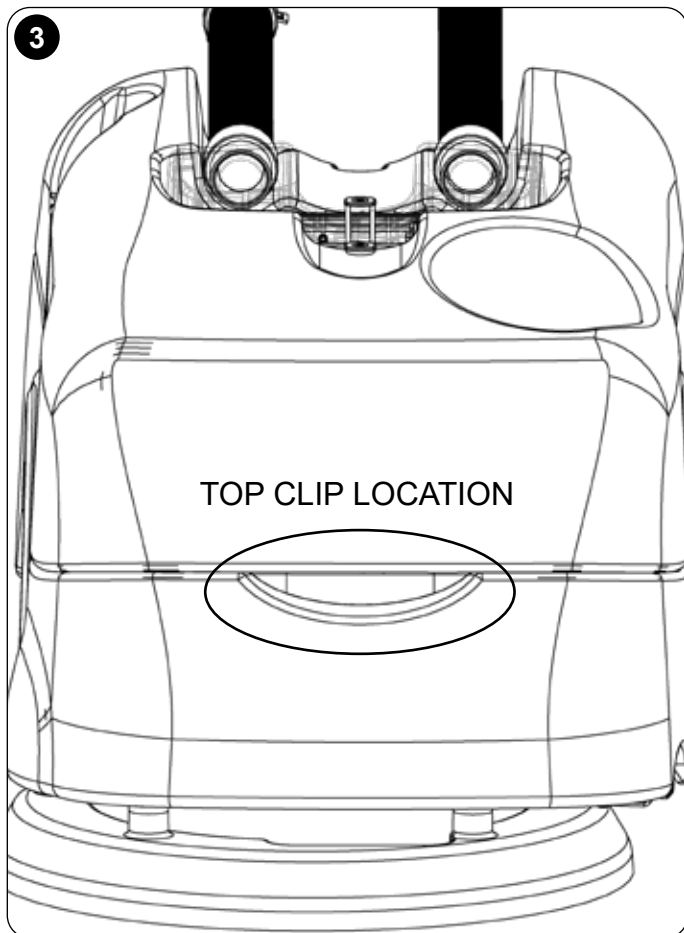

4

BOTTOM CLIPS LOCATION

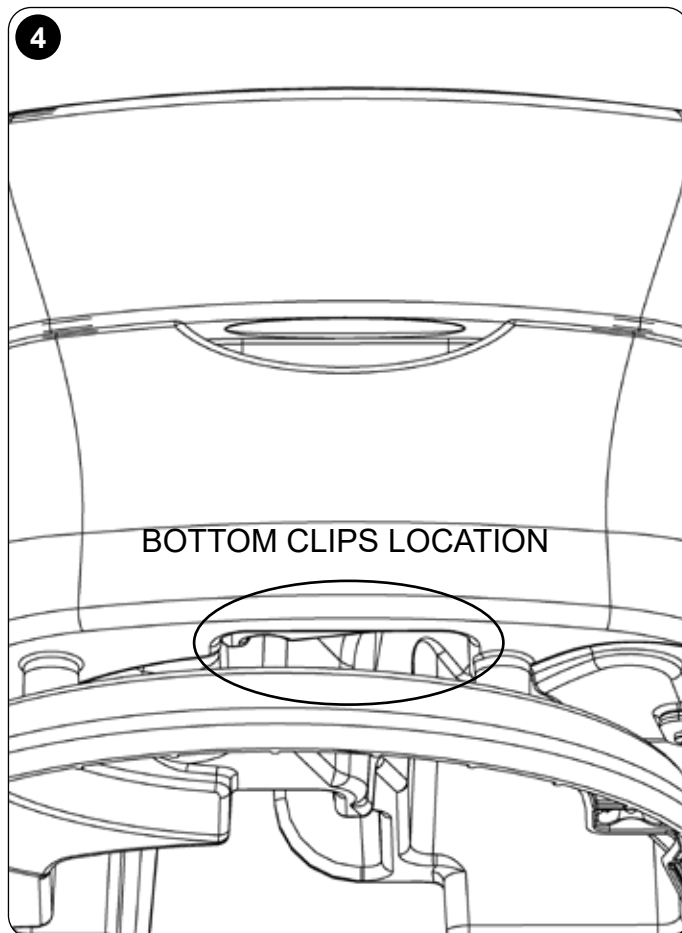

HT1840 Face Fitting Instructions

5

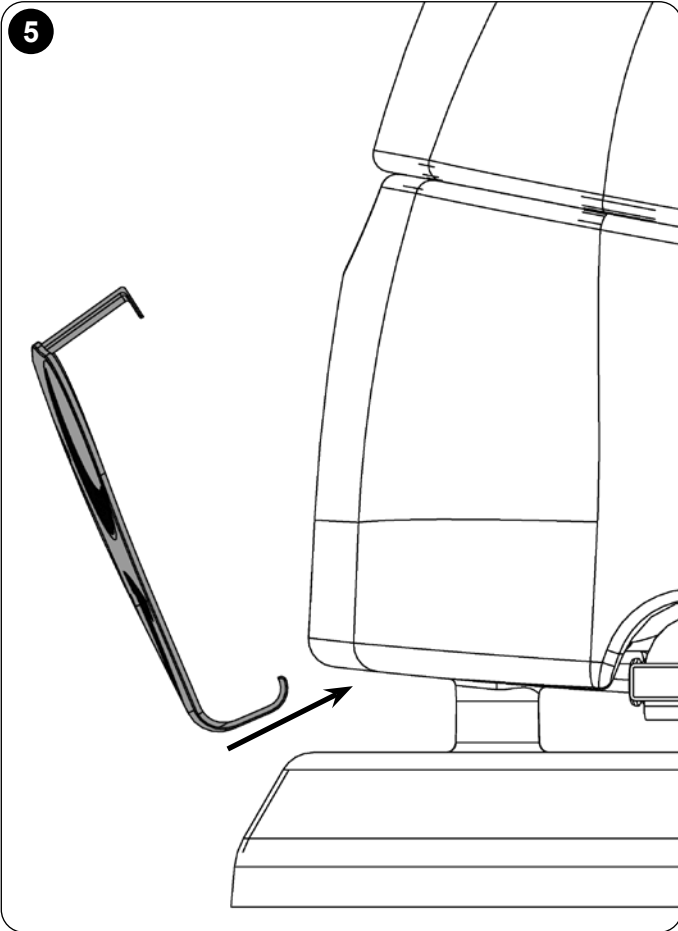

6

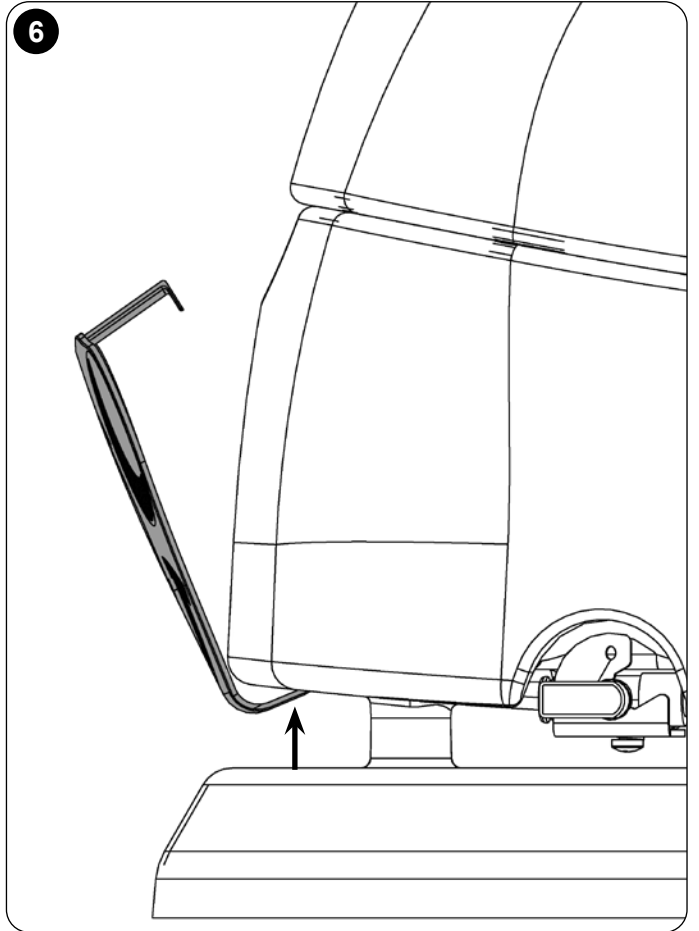

7

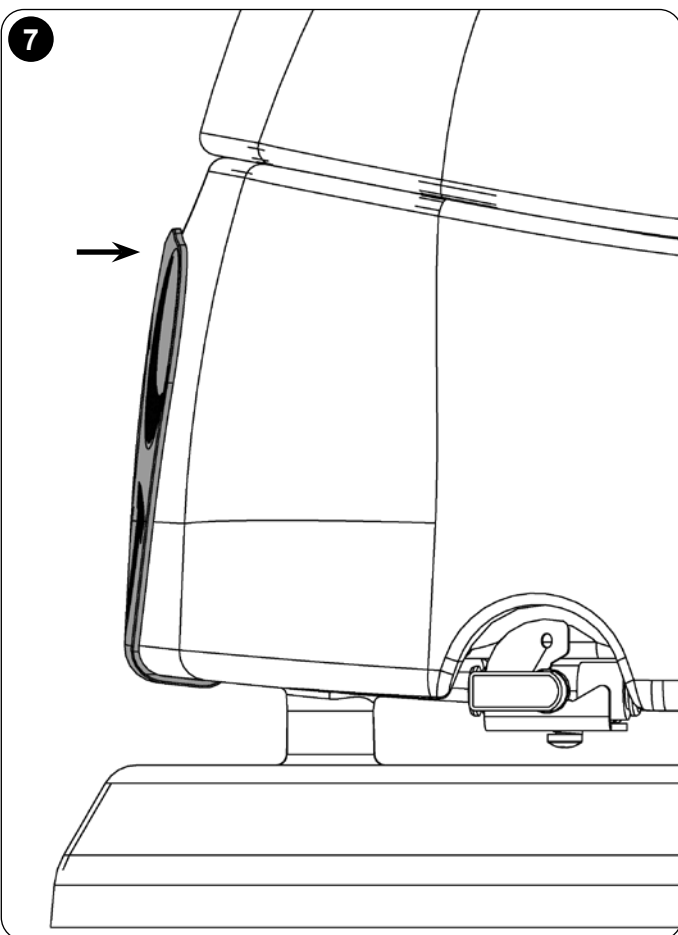

8

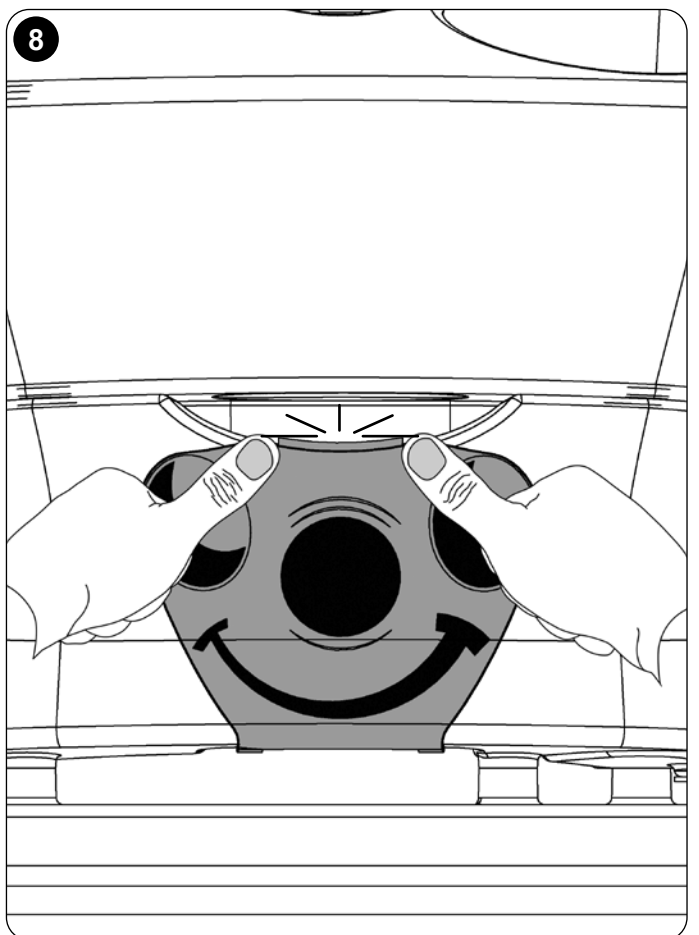

Numatic International Warranty

Numatic International Limited warrant to the original purchaser that its products are free of defects in both material or workmanship for the period shown below:-

Homecare and Cleancare Vacuum cleaners.....	2 Years
Rotary Floor Machines.....	2 Years
Twintec Auto Scrubber Dryer.....	1 Year
Vario Ride-On Scrubber Dryer.....	1 Year / 1500 hours
Mopping, Compacts, Combi and Servocare Products.....	1 Year
Individual Accessories and Spare Parts.....	6 Months

Note: This warranty expressly excludes consumable parts such as carbon brushes, floor brushes, mops, batteries etc, that are considered replaceable from time to time during the normal working life of the machine.

Using non Numatic dustbags can be detrimental to both machine performance and life and may invalidate the Warranty.

A. The warranty period commences from the date the goods are purchased.

B. All warranty claims must be processed through the Dealer from whom the equipment was purchased. The Dealer will co-operate with the purchaser throughout the warranty claims procedure and will arrange any necessary repairs using genuine Numatic parts.

C. If the original Dealer is no longer able to fulfil his obligations please contact Numatic International Limited with full details of the claim and proof of purchase so that this may be processed without delay.

D. Any warranty claim can only relate to the specific part that is proven to be at fault and for which a replacement will be supplied but cannot be extended to constitute a claim against the complete machine.

E. Numatic International will supply the Dealer with any warranty parts required, subject to the claim being validated, after return of the faulty items in accordance with Numatic International Limited's General Conditions of Sale.

F. Claims will not be accepted if they are the result of fair wear and tear, misuse or abuse of any kind.

G. No replacement will be given unless the appropriate evidence of the validity of the claim has been provided to the satisfaction of Numatic International Limited.

H. Numatic International Limited reserve the right to charge for any unnecessary work carried out as a result of an invalid claim.

I. No variation to this warranty may be made or implied by any member of Numatic International Limited or its Dealers unless such variation is in writing and authorised by the Company



Numatic International Limited. Chard, Somerset, TA20 2GB

Telephone: 01460 68600 Fax: 01460 68458

© Numatic International Limited

<p>UKCA Declaration of Conformity</p> <p>Manufacturer: Numatic International Limited Chard Somerset TA20 2GB www.numatic.co.uk TT1840, HT1840</p> <p>Product: Floor Treatment - Walk Behind – Commercial</p>	<p>Declaration of Conformity Prohlášení o shodě Konformitátsertifikační prohlášení Declaración de conformidad Declaração de conformidade</p> <p>EU, EC, EL, UE, ES: Declaración de conformidad Δήλωση ομοφωνίας Megfelelőségi nyilatkozat Dichiarazione di conformità Atihkites deklaracija Conformiteitsverklaring Samsvarserklæring Declaração de conformidade</p>	<p>Manufacturer: / Výrobce / Hersteller / Fabricant / Fabricante / Тоотја / Fabricant / произвођитељ / Κορκακωσαστής / Gyártó / Fabricante / Gamintojas / Fabrikant / Produzent / Fabricant / Producent / Producător / произвођитељ / Tilvarekare / Proizvajalec / Valmistaja:</p> <p>Product: / Produkt / Produkt / Produkt / Producto, Toode, Produkt / Продукт / Протоў / Termék / Prodotto / Produktas / Artikel / Produkt / Produtos / Produkt / Prodsus / товар / Produkt / izdelka / Tuote:</p> <p>Description: / Opis / Beschreibung / Beskrivelse / Descripción / Kirjeldus / La description / Описание / Περιγραφή / Leitárs / Descripción / Description / Arbutudimás / Omschrijving / Beskrivelse / Descrição / Opis / Descrigrere / Описание / Beskrivning / Opis / Kuvaus:</p>	<p>GB We, Numatic hereby declare under our sole responsibility, that the above-mentioned product(s) is/are in conformity with the following directives and standards.</p> <p>CZ My, Numatic prohlašujeme na svou výlučnou odpovědnost, že výše uvedeny výrobek je ve shodě s následujícími směrnici a normami.</p> <p>DE Wir, Numatic erklären in alleiniger Verantwortung, dass das oben genannte Produkt den folgenden Richtlinien und Normen entspricht.</p> <p>DK Vi, Numatic erklærer hermed under eget ansvar at ovennævnte produkt(er) er i overensstemmelse med følgende direktiver og standarder.</p> <p>ES Nosotros, Numatic declaramos bajo nuestra única responsabilidad que el producto antes mencionado está en conformidad con las siguientes directivas y normas</p> <p>EE Meie, Numatic käsitseme alla kinnitame ja nimetatud toode on kooskõlas järgmistele direktiivide ja</p> <p>FR Numatic déclare sous notre seule responsabilité que le produit mentionné ci-dessus est conforme aux directives et normes suivantes.</p>	<p>EU, EC, EL, UE, ES: Declaración de conformidad Δήλωση ομοφωνίας Megfelelőségi nyilatkozat Dichiarazione di conformità Atihkites deklaracija Conformiteitsverklaring Samsvarserklæring Declaração de conformidade</p> <p>Manufacturer: / Výrobce / Hersteller / Fabricant / Fabricante / Тоотја / Fabricant / произвођитељ / Κορκακωσαστής / Gyártó / Fabricante / Gamintojas / Fabrikant / Produzent / Fabricant / Producent / Producător / произвођитељ / Tilvarekare / Proizvajalec / Valmistaja:</p> <p>Product: / Produkt / Produkt / Produkt / Producto, Toode, Produkt / Продукт / Протоў / Termék / Prodotto / Produktas / Artikel / Produkt / Produtos / Produkt / Prodsus / товар / Produkt / izdelka / Tuote:</p> <p>Description: / Opis / Beschreibung / Beskrivelse / Descripción / Kirjeldus / La description / Описание / Περιγραφή / Leitárs / Descripción / Description / Arbutudimás / Omschrijving / Beskrivelse / Descrição / Opis / Descrigrere / Описание / Beskrivning / Opis / Kuvaus:</p> <p>GB We, Numatic hereby declare under our sole responsibility, that the above-mentioned product(s) is/are in conformity with the following directives and standards.</p> <p>CZ My, Numatic prohlašujeme na svou výlučnou odpovědnost, že výše uvedeny výrobek je ve shodě s následujícími směrnici a normami.</p> <p>DE Wir, Numatic erklären in alleiniger Verantwortung, dass das oben genannte Produkt den folgenden Richtlinien und Normen entspricht.</p> <p>DK Vi, Numatic erklærer hermed under eget ansvar at ovennævnte produkt(er) er i overensstemmelse med følgende direktiver og standarder.</p> <p>ES Nosotros, Numatic declaramos bajo nuestra única responsabilidad que el producto antes mencionado está en conformidad con las siguientes directivas y normas</p> <p>EE Meie, Numatic käsitseme alla kinnitame ja nimetatud toode on kooskõlas järgmistele direktiivide ja</p> <p>FR Numatic déclare sous notre seule responsabilité que le produit mentionné ci-dessus est conforme aux directives et normes suivantes.</p>
<p>2006/42/EC</p> <p>2014/30/EU</p> <p>2011/65/EU</p>	<p>2006/42/EC</p> <p>2014/30/EU</p> <p>2011/65/EU</p>	<p>Machine Directive</p> <p>EMC Directive</p> <p>RoHS Directive</p>	<p>EN60335-1:2012 + AC:2014 + A11:2014 + A13:2017 EN60335-2-72:2012 EN62233:2008</p> <p>EN55014-1:2017 + A11:2020 EN55014-2:1997 + A1:2001 + A2:2008 EN61000-3-2:2014 EN61000-3-3:2013</p>	

<p>UKCA Declaration of Conformity</p> <p>Manufacturer: Numatic International Limited Chard Somerset TA20 2GB www.numatic.co.uk TT1840, HT1840</p> <p>Product: Floor Treatment - Walk Behind – Commercial</p>	<p>Declaration of Conformity Prohlášení o shodě Konformitátsertifikační prohlášení Declaración de conformidad Declaração de conformidade</p>	<p>Manufacturer: / Výrobce / Hersteller / Fabricant / Fabricante / Тоотја / Fabricant / произвођитељ / Κορκακωσαστής / Gyártó / Fabricante / Gamintojas / Fabrikant / Produzent / Fabricant / Producent / Producător / произвођитељ / Tilvarekare / Proizvajalec / Valmistaja:</p> <p>Product: / Produkt / Produkt / Produkt / Producto, Toode, Produkt / Продукт / Протоў / Termék / Prodotto / Produktas / Artikel / Produkt / Produtos / Produkt / Prodsus / товар / Produkt / izdelka / Tuote:</p> <p>Description: / Opis / Beschreibung / Beskrivelse / Descripción / Kirjeldus / La description / Описание / Περιγραφή / Leitárs / Descripción / Description / Arbutudimás / Omschrijving / Beskrivelse / Descrição / Opis / Descrigrere / Описание / Beskrivning / Opis / Kuvaus:</p>	<p>GB We, Numatic hereby declare under our sole responsibility, that the above-mentioned product(s) is/are in conformity with the following directives and standards.</p> <p>CZ My, Numatic prohlašujeme na svou výlučnou odpovědnost, že výše uvedeny výrobek je ve shodě s následujícími směrnici a normami.</p> <p>DE Wir, Numatic erklären in alleiniger Verantwortung, dass das oben genannte Produkt den folgenden Richtlinien und Normen entspricht.</p> <p>DK Vi, Numatic erklærer hermed under eget ansvar at ovennævnte produkt(er) er i overensstemmelse med følgende direktiver og standarder.</p> <p>ES Nosotros, Numatic declaramos bajo nuestra única responsabilidad que el producto antes mencionado está en conformidad con las siguientes directivas y normas</p> <p>EE Meie, Numatic käsitseme alla kinnitame ja nimetatud toode on kooskõlas järgmistele direktiivide ja</p> <p>FR Numatic déclare sous notre seule responsabilité que le produit mentionné ci-dessus est conforme aux directives et normes suivantes.</p>	<p>S.I. 2008: 1597</p> <p>S.I. 2016: 1091</p> <p>S.I. 2012: 3032</p>	<p>Supply of Machinery Regulations</p> <p>EMC Regulations</p> <p>RoHS Regulations</p>	<p>EN60335-1:2012 + AC:2014 + A11:2014 + A13:2017 EN60335-2-72:2012 EN62233:2008</p> <p>EN55014-1:2017 + A11:2020 EN55014-2:1997 + A1:2001 + A2:2008 EN61000-3-2:2014 EN61000-3-3:2013</p>
<p>Authorised Signatory: Mr. Matthew Coles</p> <p>Signed: <i>M Coles</i> Date: 1st Dec 2021</p>		<p>Position: Head of Technology</p> <p>Numatic International Limited, Chard, Somerset, TA20 2GB, UK</p>		<p>Signed: <i>M Coles</i> Date: 04th May 2022</p> <p>Authorised Signatory: Mr. Matthew Coles</p> <p>Position: Head of Technology</p> <p>Numatic International Limited Chard, Somerset, TA20 2GB, UK</p>		

Distributed by:

Numatic

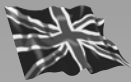

Numatic International Limited.
Chard, Somerset TA20 2GB ENGLAND
Tel: 01460 68600 www.numatic.co.uk



Numatic International GmbH. Fränkische Straße 15–19
D-30455 Hannover, DEUTSCHLAND
Tel: 05 11 98 42 16 0 www.numatic.de

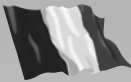

Numatic International SAS. 13 / 17 rue du Valengelier
EAE La Tuilerie, 77500 CHELLES, FRANCE
Tel: 01 64 72 61 61 www.numatic.fr



Numatic International BV, Vennootsweg 15
2404 CG, Alphen aan den Rijn, Nederland
Tel: 0172 467 999 www.numatic.nl

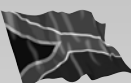

Numatic International (Pty.) Ltd.
16th & Pharmaceutical Roads, Midrand, Gauteng,
SOUTH AFRICA 1685
Tel: 0861 686 284 www.numatic.co.za



Numatic International Schweiz AG.
Sihlbruggstrasse 3A, 6340 Baar. SCHWEIZ
Tel: 0041 (0) 41 76 80 76 - 0 www.numatic.ch

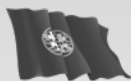

Numatic International ULDA. Rua da Boa Viagem, 177
4470.210 Maia. PORTUGAL
Tel: +351 220 047 700 www.numatic.pt



Numatic International SLU. C/ La Forja, 41, 08840 Viladecans
(Barcelona), Spain
Tel: +34 93 647 22 22 www.numatic.es

This Product has been comprehensively inspected and checked during every stage of its manufacture.
Including an in-depth electrical safety and functionality test.

Specification subject to change without prior notice
numatic.com © Numatic International Limited

244163 06/22 (A15)