

## Original Instructions



**CAUTION, Read instructions before using the machine**

### Operating Instructions

WV 1500, WVD 1500, WV 2000, WVD 2000

WV 1500-AP, WVD 1500-AP, WV 2000-AP, WVD 2000-AP



**Numatic**  
INTERNATIONAL

[www.numatic.com](http://www.numatic.com)

WVD-2000AP



WV 1500AP

WV 2000AP

WVD 1500AP

WVD 2000AP



WV 1500  
WVD 1500

WV 2000  
WVD 2000



BS7



WVD-2000



10mm



WVD-2000AP



1



2



3

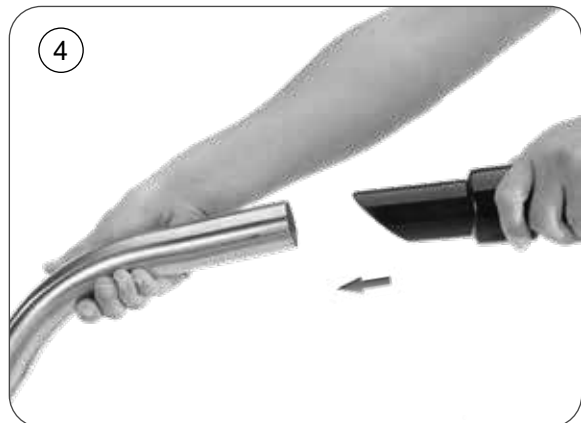

4

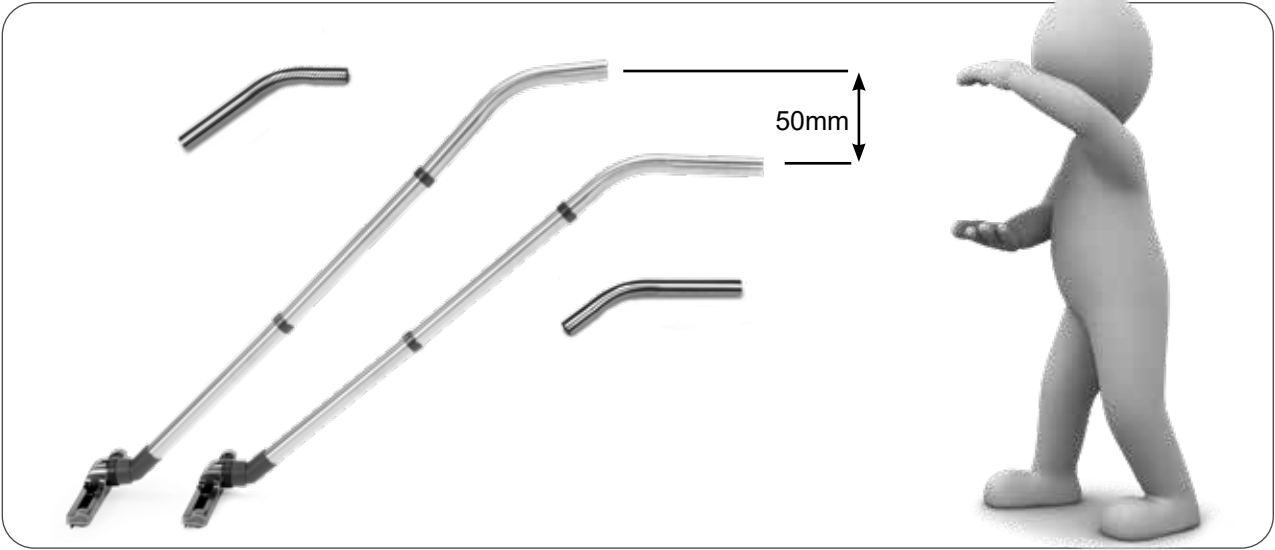

*WV 1500AP  
WVD 1500AP  
WV 2000AP  
WVD 2000AP*



*WV 1500  
WVD 1500  
WV 2000  
WVD 2000*

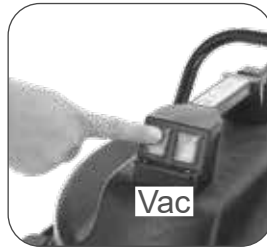

*WV 1500AP  
WVD 1500AP  
WV 2000AP  
WVD 2000AP*

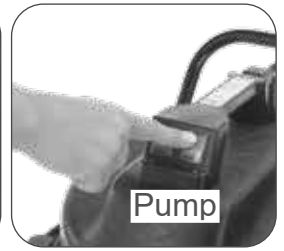





WV 1500, WVD 1500, WV 2000, WVD 2000



WV 1500AP, WVD 1500AP, WV 2000AP, WVD 2000AP



204245  
10M Hose

1



2



3



4



5

6

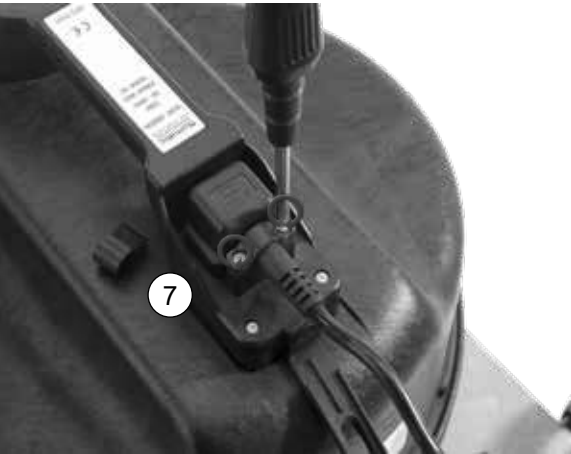

7

8



7

# (GB) About your machine

## Rating Label

1	Company Name & Address
2	Model
3	Voltage/Alternating Current
4	Frequency
5	Rated Input Power
6	Weight
7	Ingress Protection
8	WEEE Logo
9	Protection Class 2 Symbol
10	Approval Mark
11	Machine yr/wk Serial Number

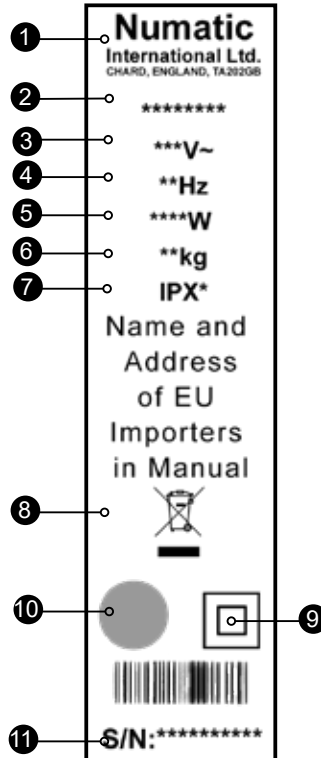

### Daily

Keep the machine clean, including hoses and tubes.

Ensure the bag and filter are fitted, (Dry use). Empty dust bag if required.

Clean and check float safety valve for signs of damage.

Regularly examine the power cord.

Check filters are clean.

### Weekly - as daily and:-

Check for any worn or damaged parts and replace immediately.

**MAINTENANCE**

## WEEE Legislation (Waste, Electrical and Electronic Equipment)

Vacuum cleaner, accessories and packaging should be sorted for environmentally - friendly recycling.

### (Only for EU Countries)

Do not dispose of vacuum cleaner into household waste! According to the European Directive 2012/19/EU on waste electrical and electronic equipment and its incorporation into national law.

Vacuum cleaners that are no longer suitable for use must be separately collected and sent for recovery in an environmentally - friendly manner.



**PPE (personal protective equipment).** That may be required for certain operations.

Ear Protection	Safety Footwear	Head Protection	Safety Gloves	
Eye Protection	Protective Clothing	Dust / Allergens Protection	Hi Viz Jacket	

**NOTE:** A risk assessment should be conducted to determine which PPE should be worn.

Failure to rectify the problem or in the event of a breakdown contact your Numatic dealer or the Numatic Technical helpline +44 (0)1460 269268

## Safety Critical Components

Mains leads:

HO5VV-F x 10m x 2 Core x 1.00mm<sup>2</sup>  
 HO5VV-F x 10m x 2 Core x 2.50mm<sup>2</sup>  
 HO5VV-F x 10m x 3 Core x 1.50mm<sup>2</sup>



# Information for WET & DRY use Vacuum Cleaners

## Warning

Read the instruction manual before using the machine.

Operators shall be adequately instructed on the use of these machines.

As with all electrical equipment, care and attention must be exercised at all times during use, in addition to ensuring that routine and preventative maintenance is carried out periodically to ensure safe operation. Failure to carry out maintenance as necessary, including the replacement of parts to the correct standard could render this equipment unsafe and the manufacturer can accept no responsibility in this respect.

The machine shall be disconnected from the mains power by removing the plug from the power supply socket during cleaning or maintenance and when replacing parts or converting the machine to another function.

This machine is not to be used by children or persons with reduced physical, sensory or mental capabilities, or lack of experience or knowledge.

Children being supervised are NOT to play with the machine.

This appliance is intended to be assembled, cleaned and maintained by an adult.

This machine is not a toy.

This machine is not suitable for picking up hazardous or explosive dust. Contact your local distributor if you require a machine capable of performing these tasks.

## Caution

If foam/liquid comes out of machine exhaust, switch off immediately.

Allow the accumulated liquid to drain out through the machine exhaust, check the float assembly to ensure correct operation, empty the container if full of liquid, reassemble the machine.

Immediately upon start up there will be a certain amount of liquid issuing from the machine exhaust which will be the residue of liquid still within the power head. This will be quickly discharged after which the machine should function normally.

Liquid ejected from the machine could be hazardous as a result of its temperature, pressure or chemical content.

Ensure that the filtration system fitted to the machine is suitable for the material being collected.

This machine is for indoor use only.

This machine shall be stored indoors only.

When moving from one place to another, consider the weight of the machine.

## Notes

You must ensure that the filtration system fitted to the machine is suitable for the material being collected.

This product complies with the requirements of clause 20 of IEC/EN 60335-2-69 Stability and Mechanical Hazards.

The primary use for this machine is commercial, for example in hotels, schools, hospitals, factories, shops and offices.

If the vacuum cleaner stops working, remove the plug from the power supply before investigating where the fault lies.

The vacuum cleaner should be inspected after use for damage.

The power light will illuminate, when your machine is connected to a suitable power supply (where fitted).

## Do

- Use a bag and filter at all times when using 'dry'.
- Keep your machine clean.
- Keep filters clean.
- Regularly clean the water level limiting float safety valve and examine for signs of damage or correct operation.
- Keep hoses and tubes clear.
- Replace any worn or damaged parts immediately.
- Regularly examine the power cord, if damage is found, the power cord must be replaced by a special cord available from Numatic or its service agents.

## Don't

- Use steam cleaners or pressure washers to clean the machine or use the machine in the rain.
- Immerse in water for cleaning.
- Allow any inexperienced repairs. Call the experts.
- Use wet if float valve is not functioning or fitted.
- Use to suck up hot ashes, or lighted cigarette ends.
- Run the machine over the power cable during operation as a hazard may occur.
- Pull on the cable to unplug the machine from the power supply.
- Walk over-wet carpets, upholstery or fabrics.
- Walk on clean carpets until fully dry.
- Attempt machine maintenance or cleaning unless the power supply plug has been removed from the supply outlet.
- Under any circumstances place foreign objects including (but not limited to) air fresheners, air freshener capsules or scented beads of any type into the top filter of the machine. Doing so can be dangerous and risk damage to the machine and may invalidate the machine warranty.

# Fault Finding

## Dry Mode maintenance/fault finding

If the vacuum cleaner stops working switch off and remove the plug from the wall before investigating where the fault lies. If the vacuum cleaner will not pick up any debris from the surface, switch off and remove the plug from the wall, inspect the floor tool, wands and hose for blockages, if no blockages are found, the dust bag may be full if the dust bag is not full the filter may be blocked.

## Wet mode

If the vacuum cleaner stops working switch off and remove the plug from the wall before investigating where the fault lies. If the vacuum cleaner has a blockage and will not pick up liquid, switch off and remove the plug from the wall, has the float valve operated, this will shut off the suction and the pitch of the vacuum motor will change.

Remove the power head and empty the liquid out of the container, if the container is empty, check that the floor tool wands and hose are not blocked.

Flush the system with clean water after use.

After use always inspect the machine for damage.

### Data

#### WV / WVD 1500 WD / WVD 1500AP

	Motor	AirFlo	Suction	Cleaning Range	Class
WV 1500	1060 W	49 L/sec	2400 mm	26.8m	II
WVD 1500	1060 W x2	98 L/sec	2400 mm	26.8m	II
WV 1500AP	1060 W	49 L/sec	2400 mm	26.8m	I
WVD 1500AP	1060 W x2	98 L/sec	2400 mm	26.8m	I
	Capacity Dry	Capacity Wet	Size	Weight	Sound Pressure
WV 1500	70 Ltrs	50 Ltrs	640x530x970	22.5 Kgs	73.7dB (IEC 60704-2-1) Uncertainty: 0.2 dB (A)
WVD 1500	70 Ltrs	50 Ltrs		25.0 Kgs	
WV 1500AP	70 Ltrs	50 Ltrs		29.0 Kgs	
WVD 1500AP	70 Ltrs	50 Ltrs		31.0 Kgs	

#### WV / WVD 2000 WV / WVD 2000AP

	Motor	AirFlo	Suction	Cleaning Range	Class
WV 2000	1060 W	49 L/sec	2400 mm	26.8m	II
WVD 2000	1060 W x2	98 L/sec	2400 mm	26.8m	II
WV 2000AP	1060 W	49 L/sec	2400 mm	26.8m	I
WVD 2000AP	1060 W x2	98 L/sec	2400 mm	26.8m	I
	Capacity Dry	Capacity Wet	Size	Weight	Sound Pressure
WV 2000	90 Ltrs	70 Ltrs	640x530x970	24.1 Kgs	73.7dB (IEC 60704-2-1) Uncertainty: 0.2 dB (A)
WVD 2000	90 Ltrs	70 Ltrs		28.9 Kgs	
WV 2000AP	90 Ltrs	70 Ltrs		30.4 Kgs	
WVD 2000AP	90 Ltrs	70 Ltrs		36.4 Kgs	

### 14" WV Simplex 240V / 120V.....WD-0245 (A05)

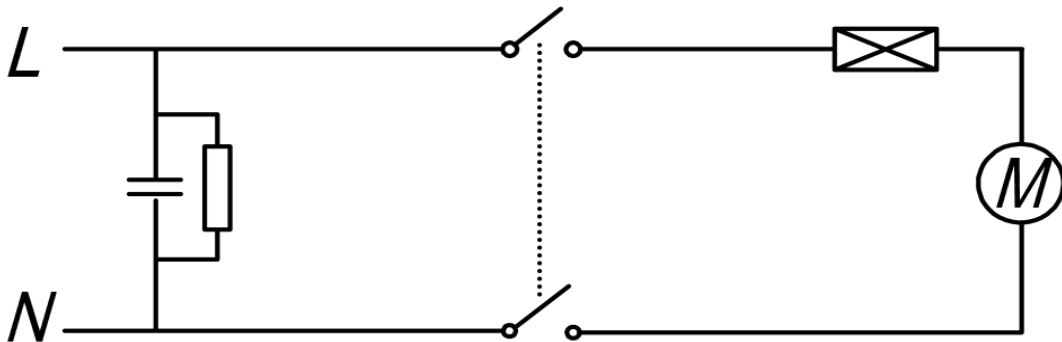

### 14" WVD Duplex 230V..... WD-0255 (A06)

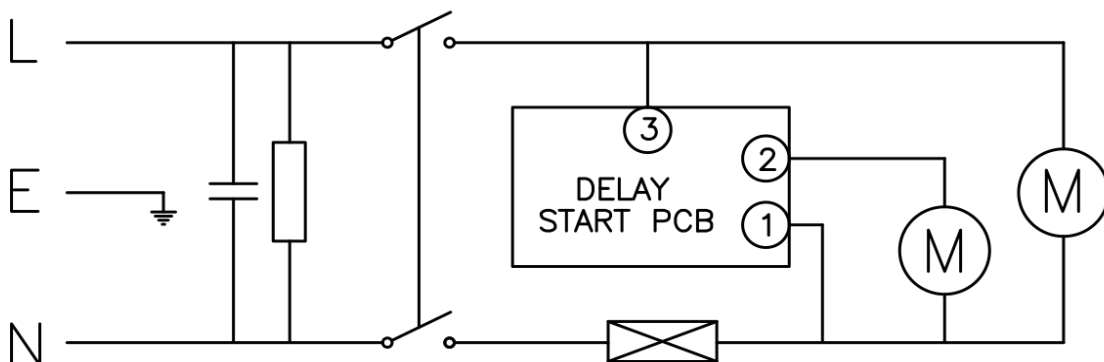

14" Duplex PTO 240V  
WD-0246 (A06)

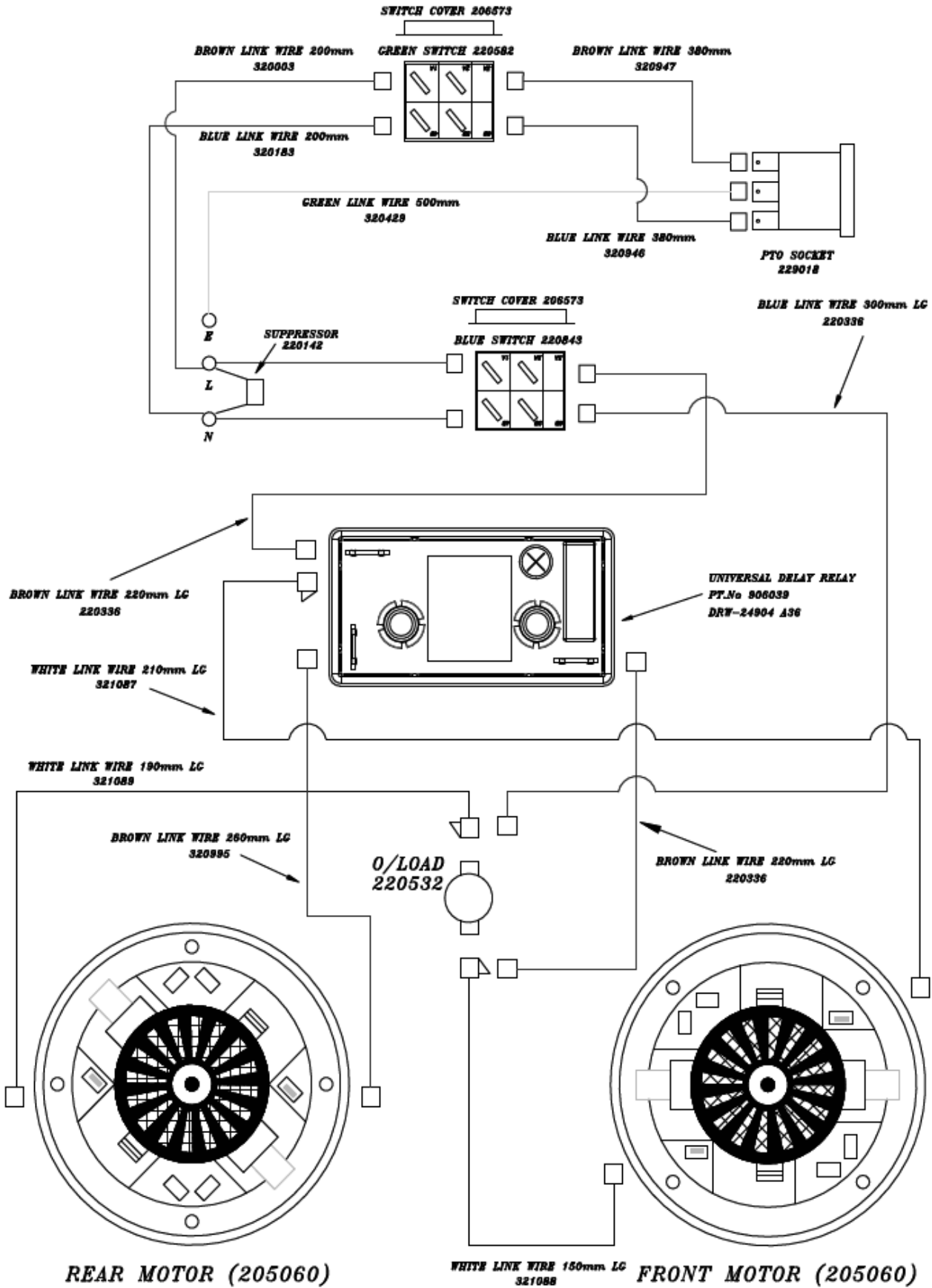

Wiring Diagram

14" Simplex AP/PH 240V / 120V  
WD-0244 (A03)

Wiring Diagram

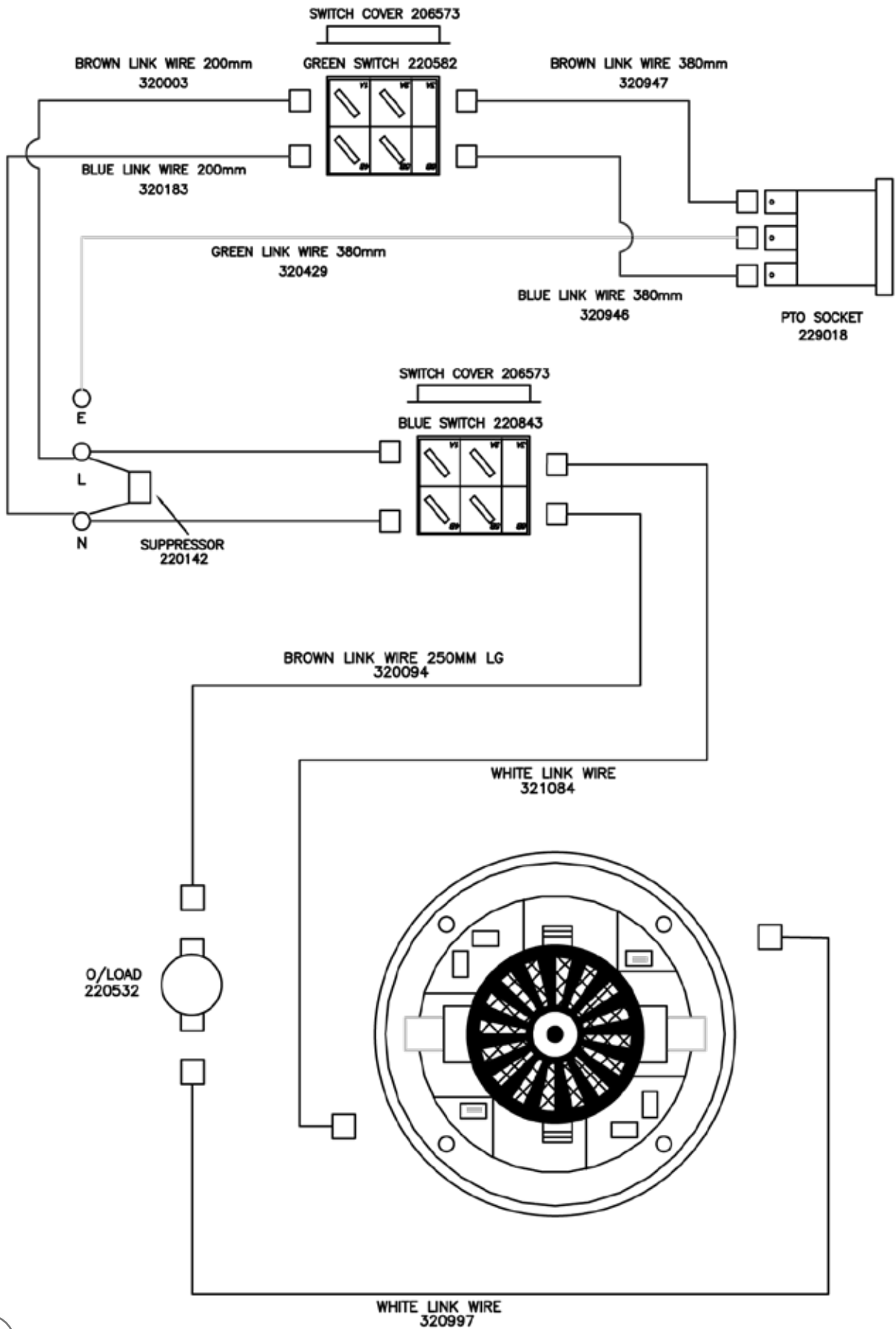

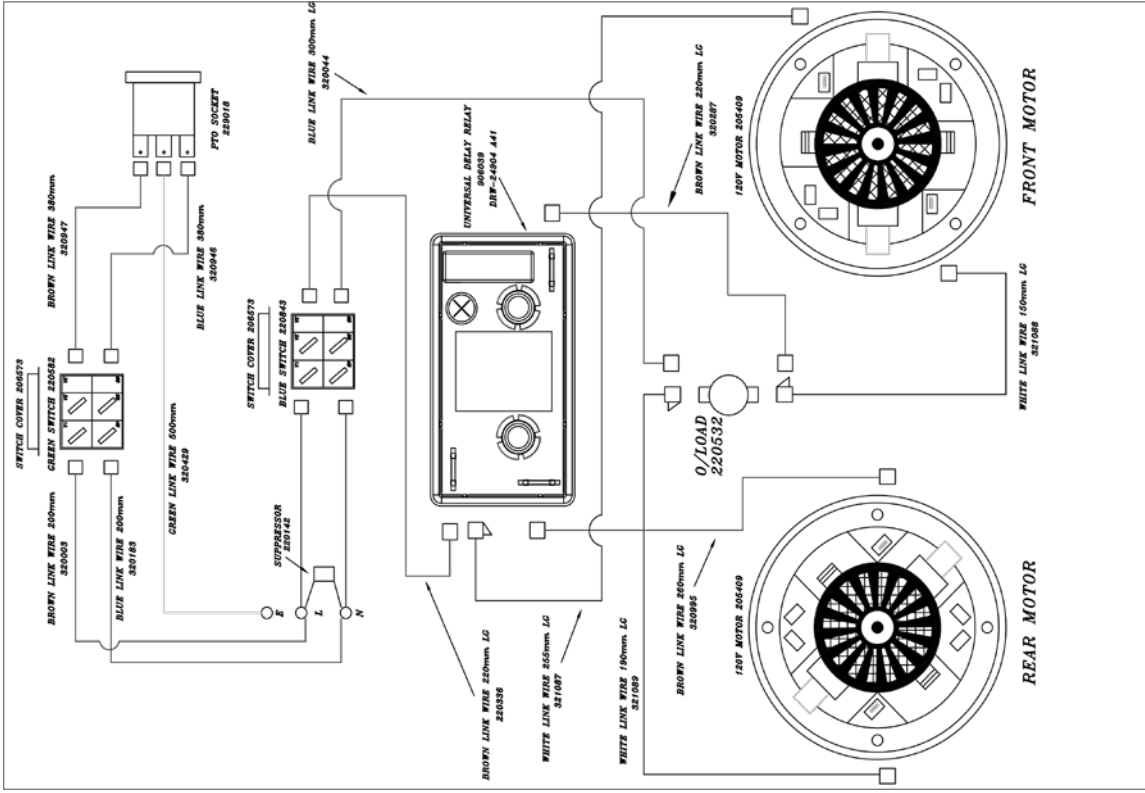

14" WW Duplex PTO 120V  
 WD-0259 (A03)

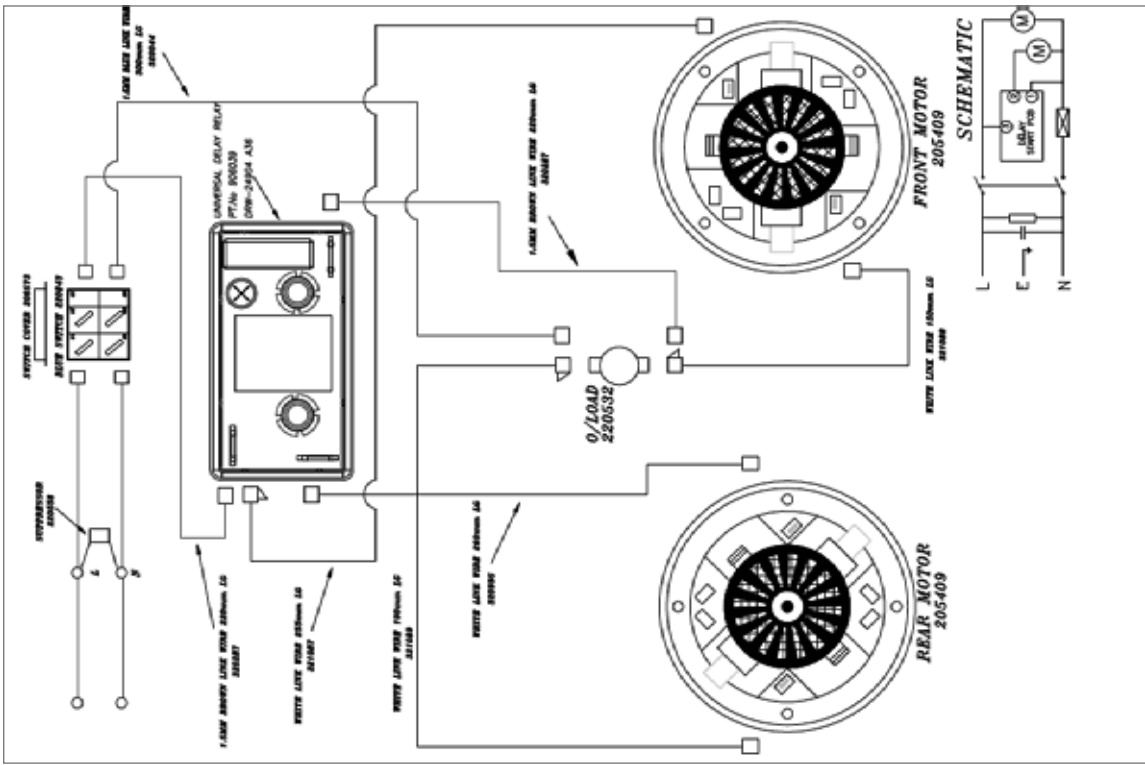

14" WW Duplex 120V  
 WD-0257 (A03)

Wiring Diagram

14" WV Simplex 220V  
WD-0289 (A01)

Wiring Diagram

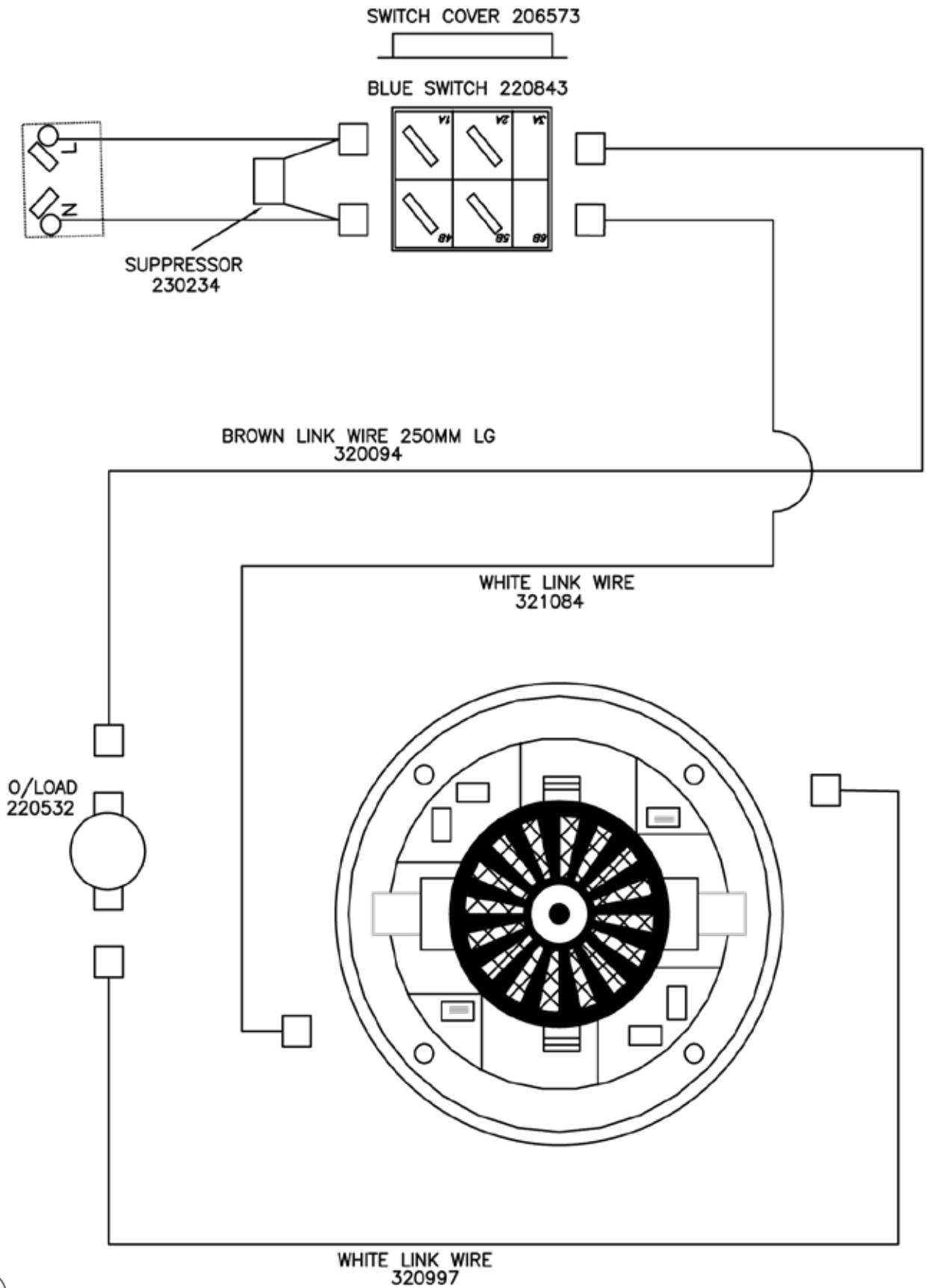

14" WV Simlex AP/PH 220V  
17/03/05 WD-0288 (A01)

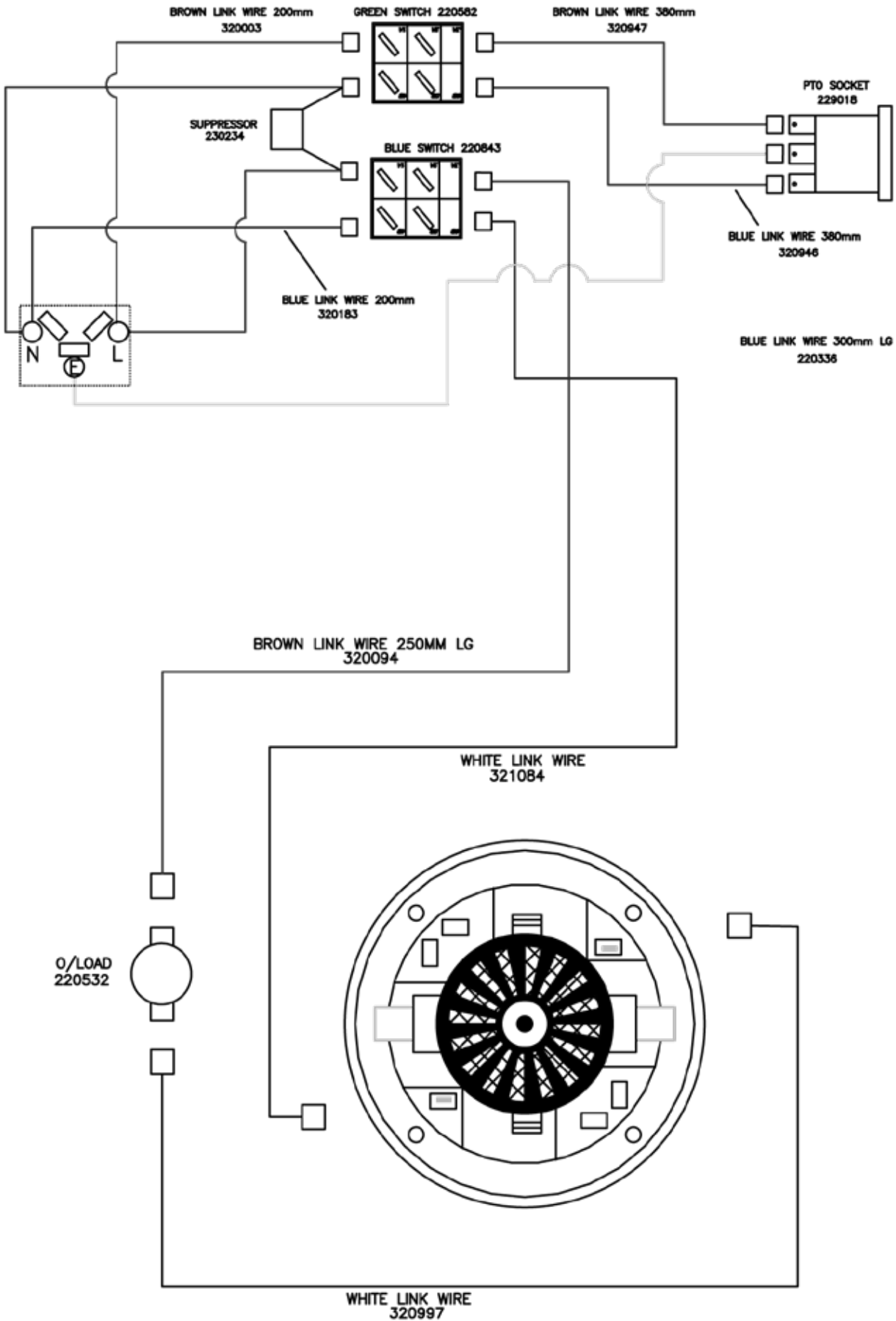

14" WV Duplex AP/PH 220V  
WD-0290 04/03/09 (A03)

Wiring Diagram

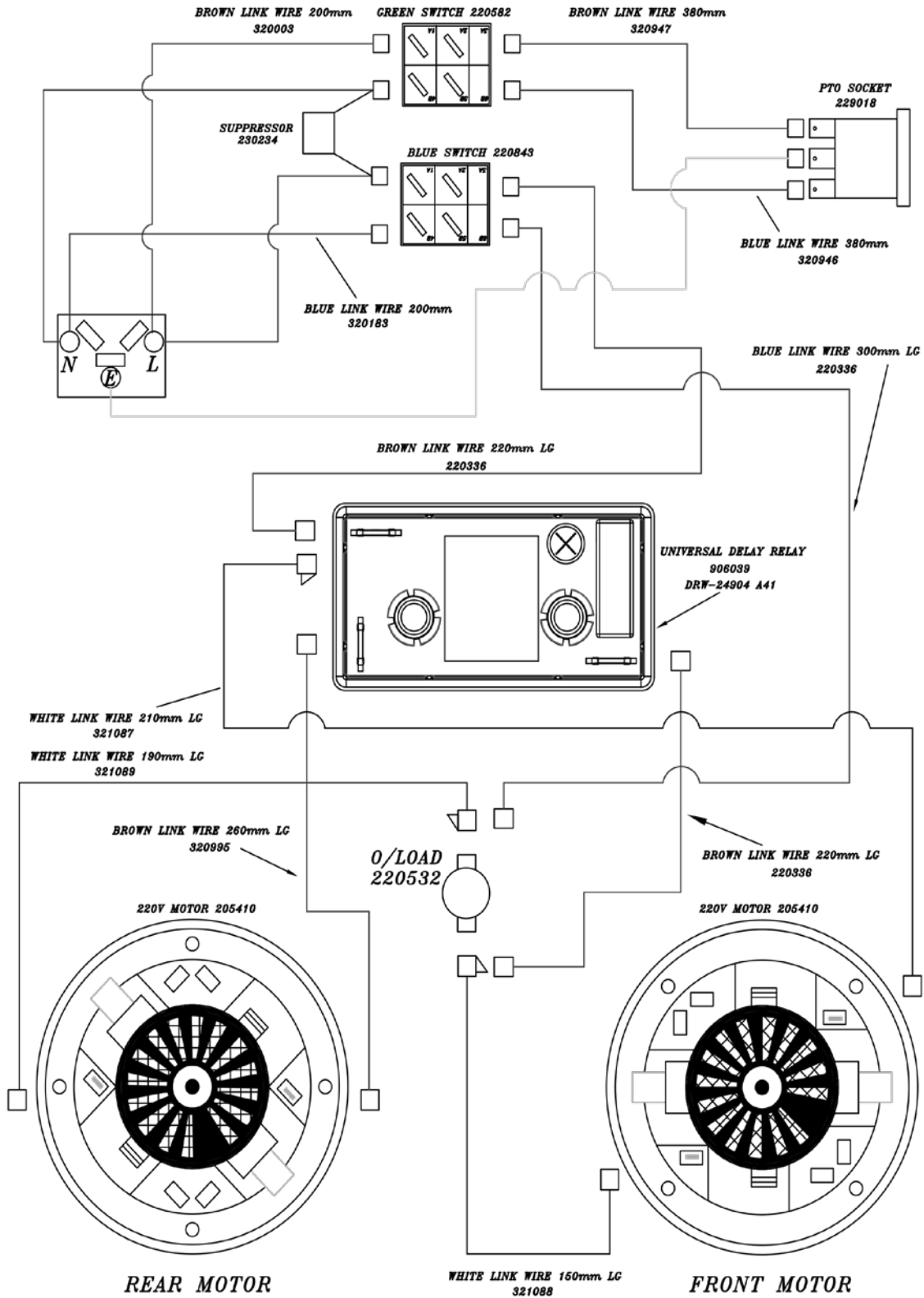



14" WV Duplex 220V  
WD-0293 05/03/09 (A03)

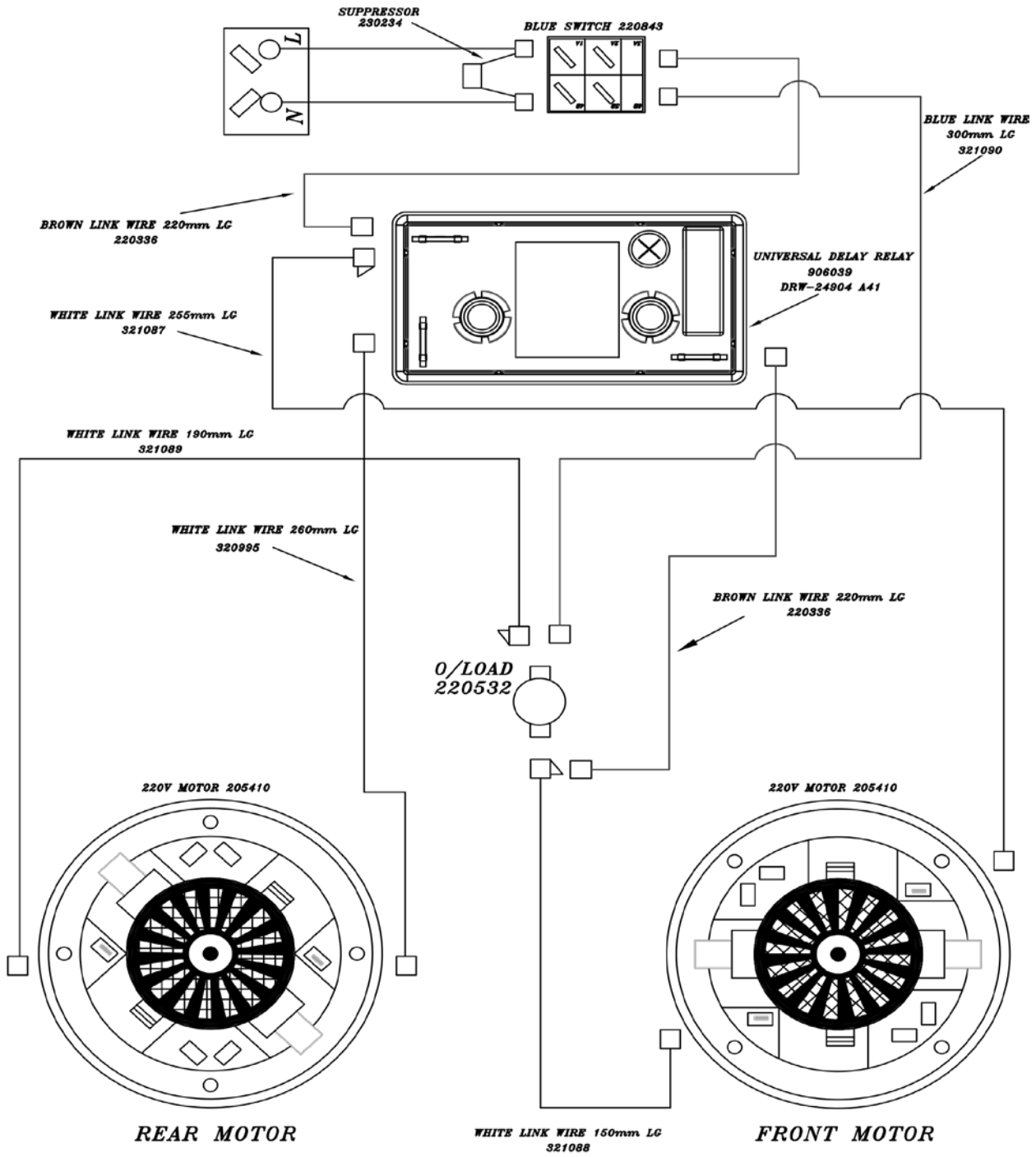

Wiring Diagram

# Numatic International Warranty

Numatic International Limited warrant to the original purchaser that its products are free of defects in both material or workmanship for the period shown below:-

Homecare and Cleancare Vacuum cleaners.....	2 Years
Rotary Floor Machines.....	2 Years
Twintec Auto Scrubber Dryer.....	1 Year
Vario Ride-On Scrubber Dryer.....	1 Year / 1500 hours
Mopping, Compacts, Combi and Servocare Products.....	1 Year
Individual Accessories and Spare Parts.....	6 Months

*Note: This warranty expressly excludes consumable parts such as carbon brushes, floor brushes, mops, batteries etc, that are considered replaceable from time to time during the normal working life of the machine.*

*Using non Numatic dustbags can be detrimental to both machine performance and life and may invalidate the Warranty.*

*A. The warranty period commences from the date the goods are purchased.*

*B. All warranty claims must be processed through the Dealer from whom the equipment was purchased. The Dealer will co-operate with the purchaser throughout the warranty claims procedure and will arrange any necessary repairs using genuine Numatic parts.*

*C. If the original Dealer is no longer able to fulfil his obligations please contact Numatic International Limited with full details of the claim and proof of purchase so that this may be processed without delay.*

*D. Any warranty claim can only relate to the specific part that is proven to be at fault and for which a replacement will be supplied but cannot be extended to constitute a claim against the complete machine.*

*E. Numatic International will supply the Dealer with any warranty parts required, subject to the claim being validated, after return of the faulty items in accordance with Numatic International Limited's General Conditions of Sale.*

*F. Claims will not be accepted if they are the result of fair wear and tear, misuse or abuse of any kind.*

*G. No replacement will be given unless the appropriate evidence of the validity of the claim has been provided to the satisfaction of Numatic International Limited.*

*H. Numatic International Limited reserve the right to charge for any unnecessary work carried out as a result of an invalid claim.*

*I. No variation to this warranty may be made or implied by any member of Numatic International Limited or its Dealers unless such variation is in writing and authorised by the Company*



**Numatic International Limited. Chard, Somerset, TA20 2GB**

**Telephone: 01460 68600 Fax: 01460 68458**

© Numatic International Limited

<b>UKCA Declaration of Conformity</b>	
<b>Manufacturer:</b>	Numatic International Limited Chard Somerset TA20 2GB www.numatic.co.uk WV, WVD, CV, CVD
<b>Product:</b>	Vacuum Cleaner – Commercial – Wet & Dry
<b>Description:</b>	
<b>We, Numatic hereby declare under our sole responsibility, that the above-mentioned product(s) is/are in conformity with the following directives and standards.</b>	
<b>S.I. 2008: 1597</b>	<b>Supply of Machinery Regulations</b> EN60335-1:2012 + AC:2014 + A11:2014 + A13:2017 EN60335-2-69:2012 EN62233:2008
<b>S.I. 2016: 1091</b>	<b>EMC Regulations</b> EN55014-1:2017 + A11:2020 EN55014-2:1997 + A1:2001 + A2:2008 EN61000-3-2:2014 EN61000-3-3:2013
<b>S.I. 2012: 3032</b>	<b>RoHS Regulations</b>

Authorised Signatory: Mr. Matthew Coles

Position: Head of Technology

Numatic International Limited,  
Chard,  
Somerset, TA20 2GB, UK

Signed:  Date: 1<sup>st</sup> Dec 2021

DEC-010 V2.0

<b>EU, EC, EL, UE, ES:</b> <b>Declaration of Conformity</b> Prohlášení o shodě Konformitátseljárung Overensstemmelseerklæring Declaración de conformidad Vastavusdeklaratsioon Déclaration de conformité	Декларация за съответствие δηλώση συμμόρφωσης Dichiarazione di conformità Försäkran om överensstämmelse Izjava o skladnosti Vaatumustenmukaisuusvakuutus	
<b>Manufacturer:</b> / Výrobce / Hersteller / Fabricant / Fabricante / Tootja / Fabricant / произодител / Кετασκευαστής / Gyártó / Fabricante / Gamintojas / Fabrikant / Produzent / Fabricante / Producent / Producător / произвождател / Тilverkare / Proizvajalec / Valmistaja:	Numatic International Limited Chard Somerset TA20 2GB www.numatic.co.uk WV, WVD, CV, CVD, SSIVD	
<b>Product:</b> / Produkt / Produkt / Produkt / Producto, Toodet, Produkt / Продакт / Προϊόν / Termék / Prodotto / Produkta / Artikel / Produkt / Products / Produkt / Produus / товар / Produkt / Izdelka / Tuote:	Vacuum Cleaner – Commercial – Wet & Dry	
<b>Description:</b> / Opis / Beschreibung / Beskrivelse / Descrição / Kirjeläus / La description / Описание / Περιγραφή / Leiras / Descricione / Apibudinimas / Omschrijving / Beskrivelse / Descrição / Opis / Descriere / Описание / Beskrivning / Opis / Kuvaus:		
<b>GB</b> We, Numatic hereby declare under our sole responsibility, that the above-mentioned product(s) is/are in conformity with the following directives and standards. <b>CZ</b> My, Numatic prohlašujeme na svou vylučnou odpovědnost, že výše uvedené výrobek je ve shodě s následujícími směrniciemi a normami. <b>DE</b> Wir, Numatic erklären in alleiniger Verantwortung, dass das oben genannte Produkt den folgenden Richtlinien und Normen entspricht. <b>DK</b> Vi, Numatic erklærer hermed under eget ansvar at ovennævnte produkt(er) er i overensstemmelse med følgende direktiver og standarder. <b>ES</b> Nosotros, Numatic declaramos bajo nuestra única responsabilidad que el producto antes mencionado está en conformidad con las siguientes directivas y normas. <b>EE</b> Meie, Numatic kätsolevaga kinnitame ja kanname ainuuskulist vastutust, et eespool nimetatud toode on kooskõlas järgmistele direktiivide ja <b>FR</b> Numatic déclare sous notre seule responsabilité que le produit mentionné ci-dessus est conforme aux directives et normes suivantes.	<b>BG</b> Ние, Numatic С настоящото декларираме на своя лична отговорност, че посочените по-горе продукти е в съответствие със следните директиви и стандарти. <b>GR</b> Εμείς, Numatic δηλώνουμε με αποκλειστική μας ευθύνη, ότι το παρααναφερόμενο προϊόν συμμορφώνεται με τις ακόλουθες οδηγίες και πρότυπα. <b>HU</b> Mi, Numatic kijelentjük, egyedül felelősséggel, hogy a fent említett termék megfelel az alábbi irányelveknek és szabványoknak. <b>IT</b> Noi, Numatic dichiara sotto la propria responsabilità, che il prodotto di cui sopra è conforme alle seguenti direttive e norme. <b>LT</b> Mes, "Numatic pareiškiu vienašališkos atsakomybės, kad pirmiau minėtas produktas atitinka šias direktyvas ir standartus. <b>NL</b> We verklaren Numatic hierbij op eigen verantwoordelijkheid, dat het bovengenoemde product voldoet aan de volgende richtlijnen en normen. <b>NO</b> Vi, Numatic erklærer hermed under eget ansvar, at det ovennevnte produkt er i samsvar med følgende direktiver og standarder.	<b>PT</b> Nós, a Numatic declaramos, sob nossa exclusiva responsabilidade, que o produto acima mencionado está em conformidade com as direttrizes e normas a seguir. <b>PL</b> My, Numatic Niniejszym oświadczamy z pełną odpowiedzialnością, że wyżej wymieniony produkt jest zgodny z następującymi dyrektywami i normami. <b>RO</b> Noi, Numatic Prin prezenta declarăm pe propria răspundere, că produsul mai sus menționat este în conformitate cu următoarele standarde și directive. <b>RU</b> Мы, Нипфичск овим изъавъујем под пуном одговорношћу, да наведеног производа, је у складу са следећим директивама и стандардима. <b>SE</b> Vi Numatic förklarar härmed under eget ansvar att ovan nämnda produkt överensstämmer med följande direktiv och normer. <b>SI</b> Mi, Numatic izjavljam s polno odgovornostjo, da je zgoraj omenjeni izdelek v skladu z naslednjimi smernicami in standardi. <b>FI</b> Me, Numatic täten vakuuttamme omalla vastuulla, että edellä mainittu tuote on yhdenmukainen seuraavien direktiivien ja standardien mukaisesti
<b>2006/AZ/EC</b>	<b>Machinery Directive</b> EN60335-1:2012 + AC:2014 + A11:2014 + A13:2017 EN60335-2-69:2012 EN62233:2008	
<b>2014/30/EU</b>	<b>EMC Directive</b> EN55014-1:2017 + A11:2020 EN55014-2:1997 + A1:2001 + A2:2008 EN61000-3-2:2014 EN61000-3-3:2013	
<b>2011/65/EU</b>	<b>RoHS Directive</b>	

Authorised Signatory: Mr. Matthew Coles

Position: Head of Technology  
Numatic International Limited  
Chard,

Signed:  Date: 04<sup>th</sup> May 2022

Somerset, TA20 2GB, UK

DEC-010 V3.1

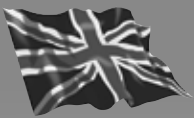

Numatic International Limited.  
Chard, Somerset TA20 2GB ENGLAND  
Tel: 01460 68600 [www.numatic.co.uk](http://www.numatic.co.uk)

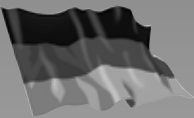

Numatic International GmbH. Fränkische Straße 15–19  
D-30455 Hannover, DEUTSCHLAND  
Tel: 05 11 98 42 16 0 [www.numatic.de](http://www.numatic.de)

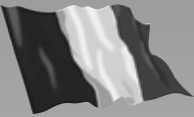

Numatic International SAS. 13 / 17 rue du Valengelier  
EAE La Tuilerie – 77500 CHELLES, FRANCE  
Tel: 01 64 72 61 61 [www.numatic.fr](http://www.numatic.fr)



Numatic International BV  
Vennootsweg 15, 2404 CG, Alphen aan den Rijn, NEDERLAND  
Tel: 0172 467 999 [www.numatic.nl](http://www.numatic.nl)

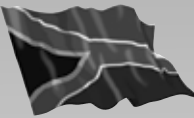

Numatic International (Pty.) Ltd.  
16th & Pharmaceutical Roads, Midrand, Gauteng,  
SOUTH AFRICA 1685  
Tel: 0861 686 284 [www.numatic.co.za](http://www.numatic.co.za)



Numatic International Schweiz AG.  
Sihlbruggstrasse 3A, 6340 Baar. SCHWEIZ  
Tel: 0041 (0) 41 76 80 76 - 0 [www.numatic.ch](http://www.numatic.ch)

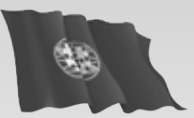

Numatic International ULDA. Rua da Boa Viagem, 177  
4470.210 Maia. PORTUGAL  
Tel: +351 220 047 700 [www.numatic.pt](http://www.numatic.pt)



Numatic International SLU. C/ La Forja, 41, 08840 Viladecans  
(Barcelona), Spain  
Tel: +34 93 647 22 22 [www.numatic.es](http://www.numatic.es)

Specification subject to change without prior notice  
[www.numatic.co.uk](http://www.numatic.co.uk) © Numatic International Limited