

AERO 21 - AERO 21 INOX

Instructions for use

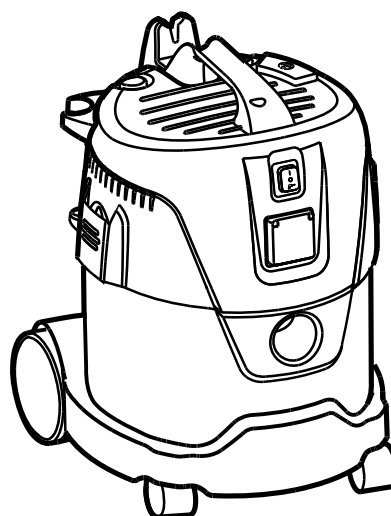
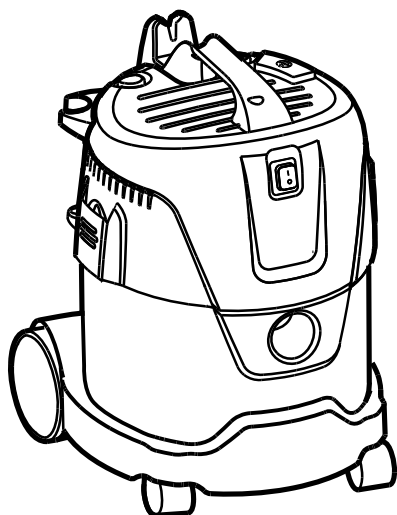
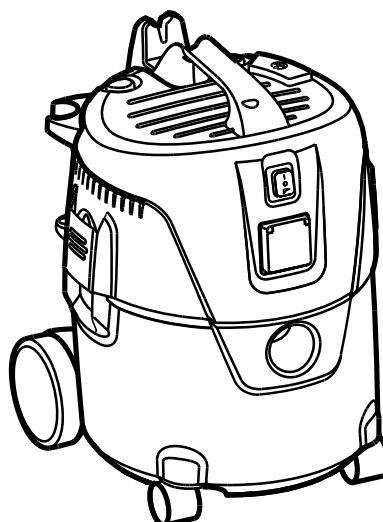
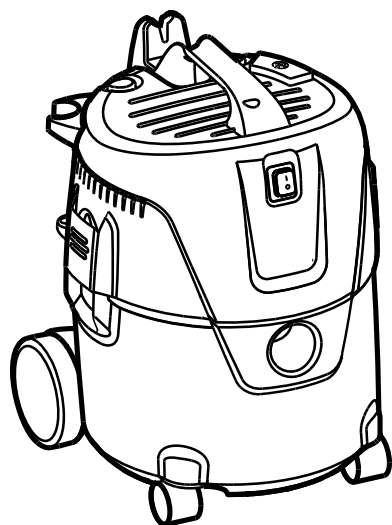

EN	Operating instructions	11
DE	Bedienungsanweisungen	18
FR	Instructions de fonctionnement	25
NL	Gebruiksaanwijzingen	32
IT	Istruzioni per l'uso	39
NO	Bruksanvisning	46
SV	Bruksanvisning	52
DA	Betjeningsvejledning	58
FI	Käyttöohje	64
ES	Instrucciones de funcionamiento	70
PT	Instruções de Funcionamento	77
EL	Οδηγίες λειτουργίας	84
TR	Kullanma Talimatları	91
SL	Navodila za delovanje	98
HR	Upute za uporabu	104
SK	Návod na obsluhu	110
CS	Návod k obsluze	117
PL	Instrukcje dotyczące obsługi	123
HU	Használati útmutató	130
RO	Instrucțiuni de utilizare	137
BG	Указания за експлоатация	144
RU	Руководство по эксплуатации	151
ET	Tööjuhised	158
LV	Norādījumi par ekspluatāciju	164
LT	Naudojimo instrukcija	171
JA	作手順.....	178
ZH	操作说明	185
KO	사용법.....	190
TH	คำแนะนำการใช้งาน	196
MS	Arahan Operasi.....	202

AERO 21-01

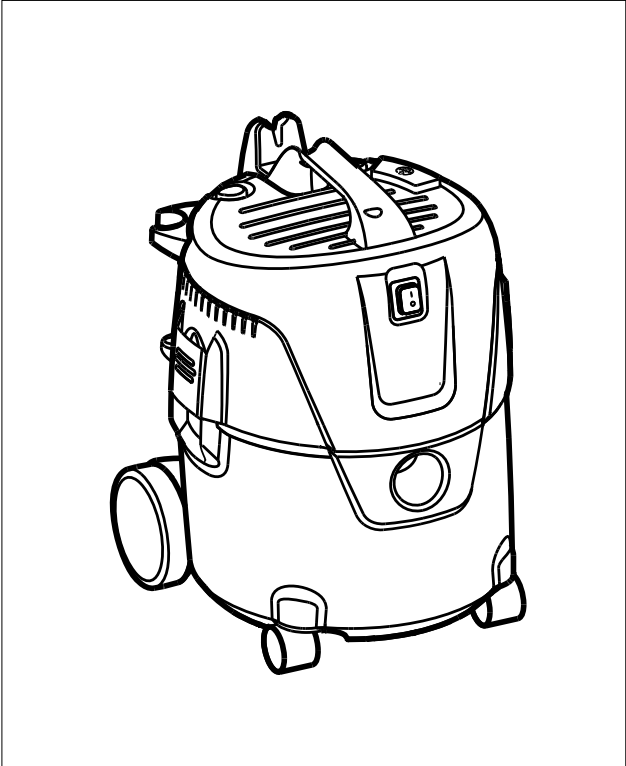

AERO 21-21

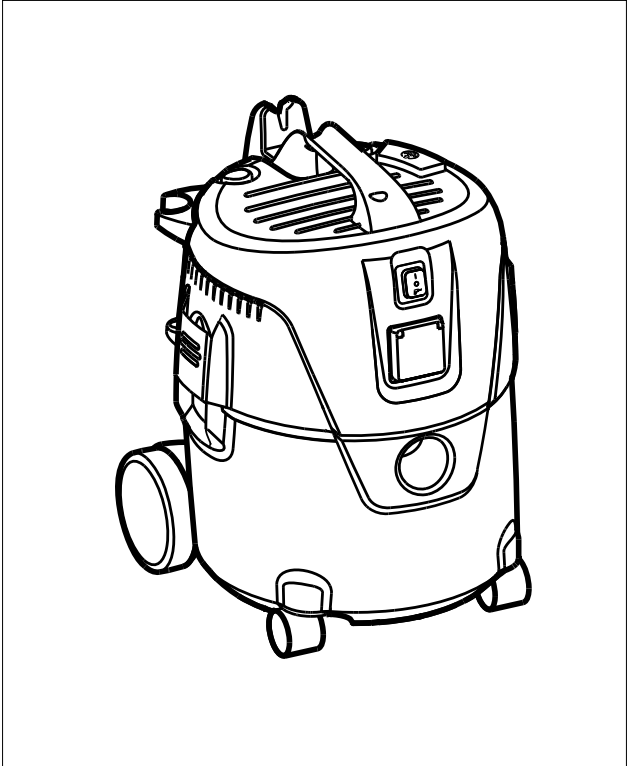

AERO 21-01 INOX

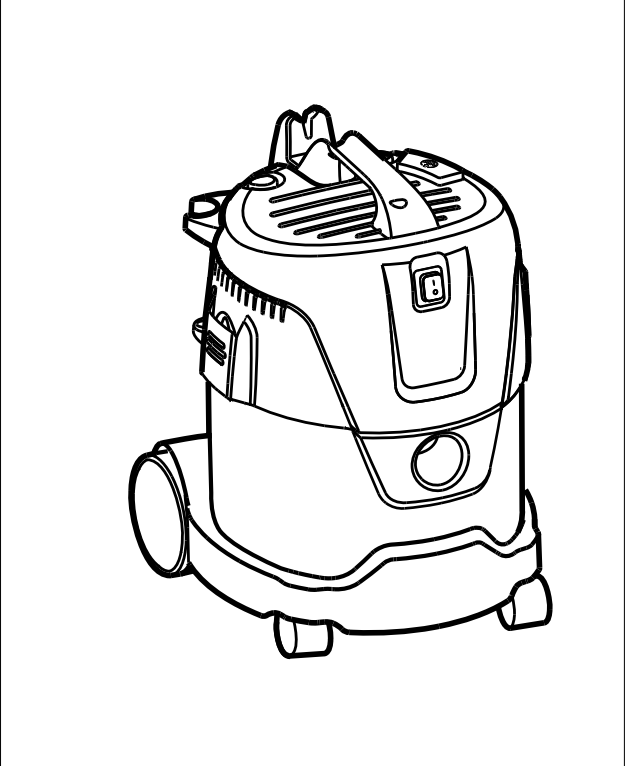

AERO 21-21 INOX

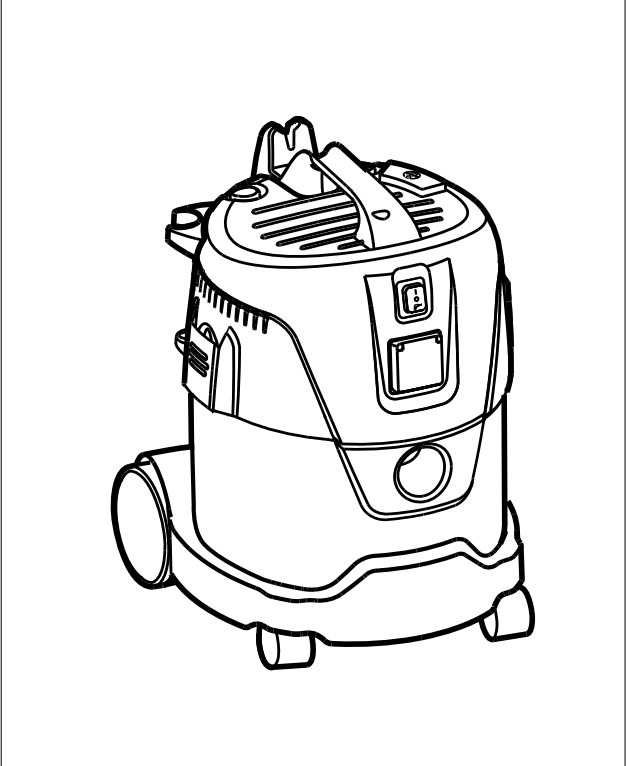

1A)

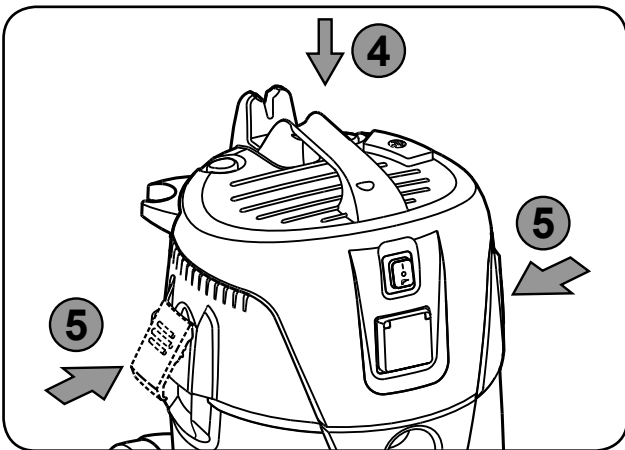
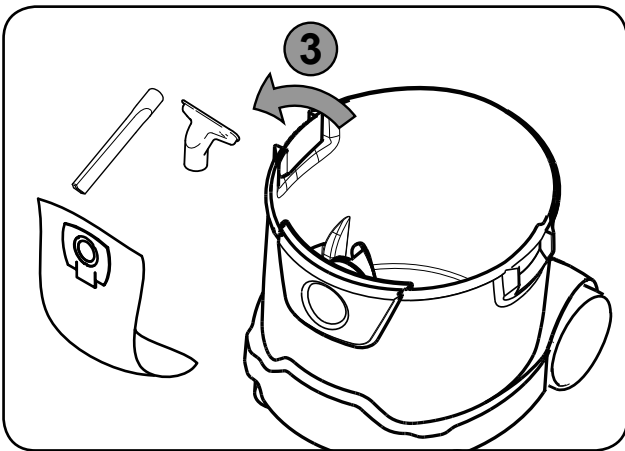
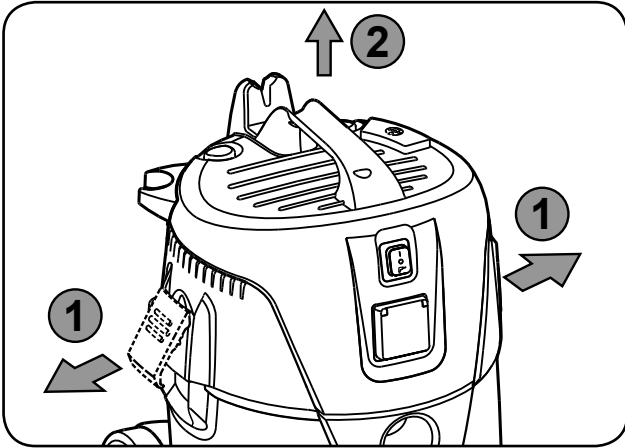

2A

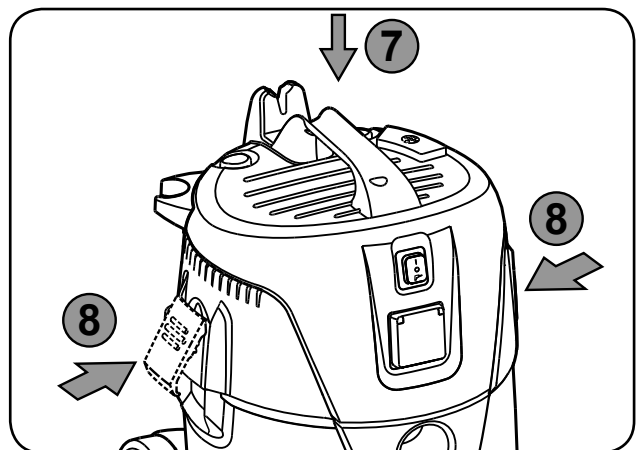
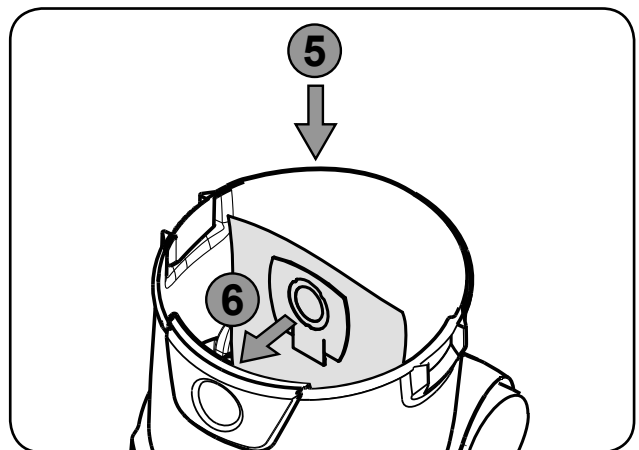
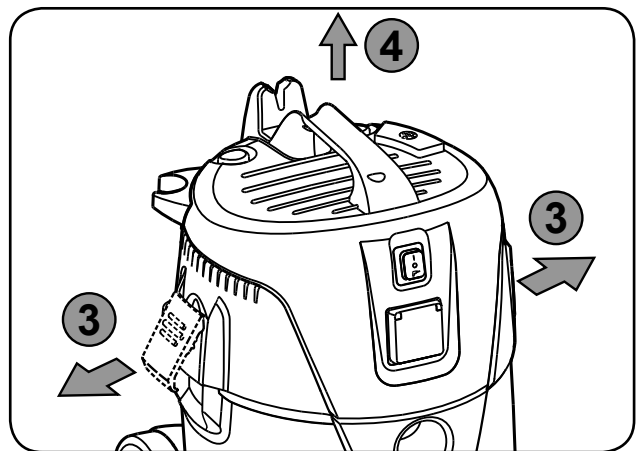
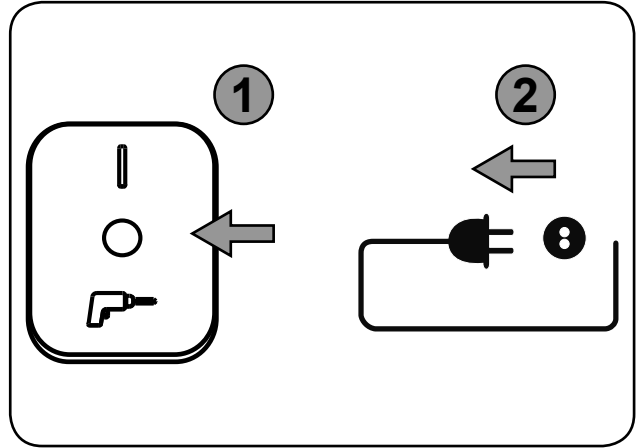

3A*)

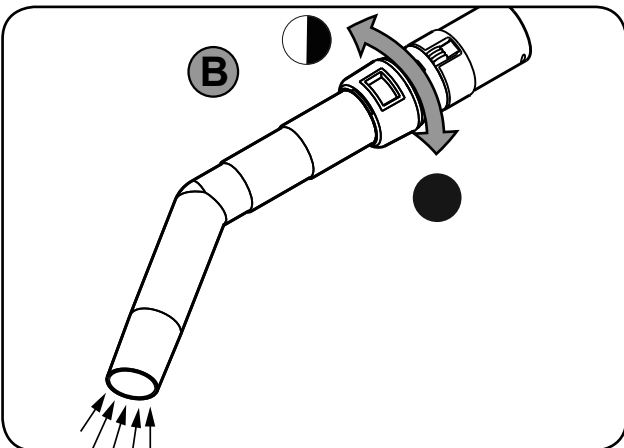
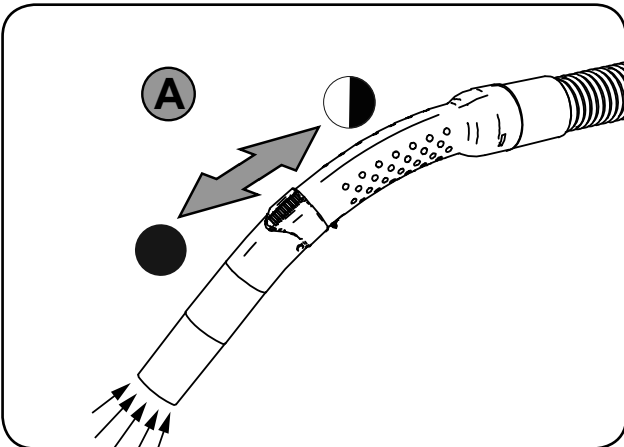
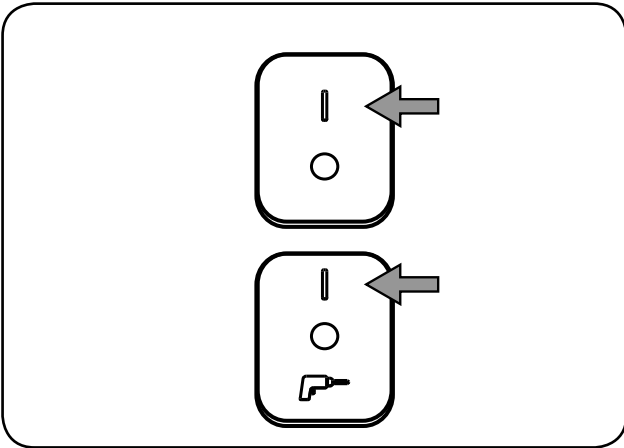
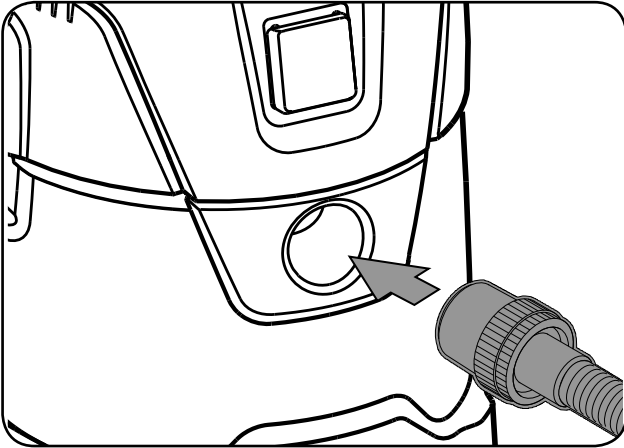

4A*)

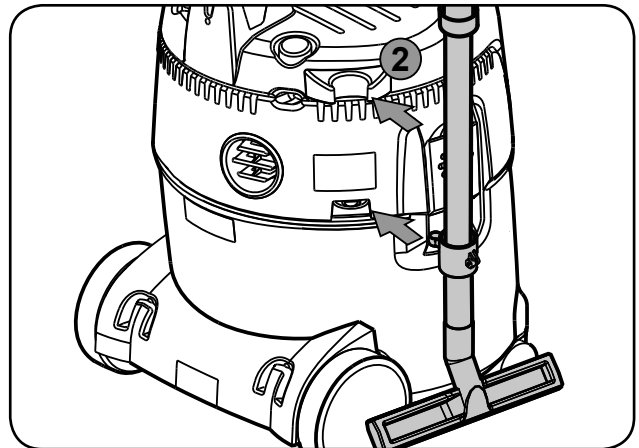
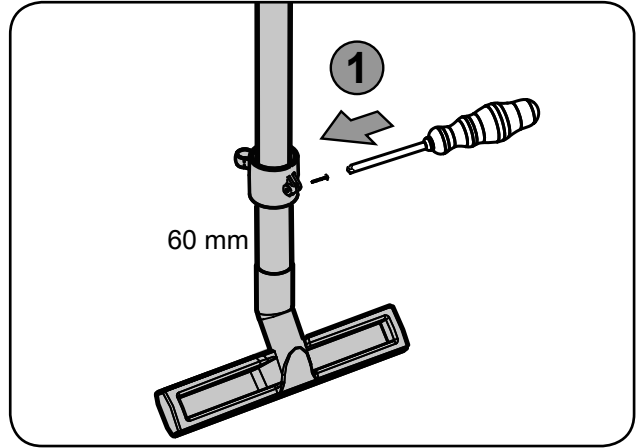

5A *)

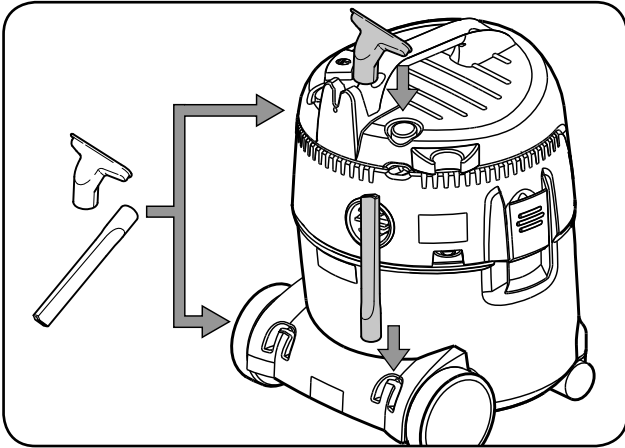

1B *)

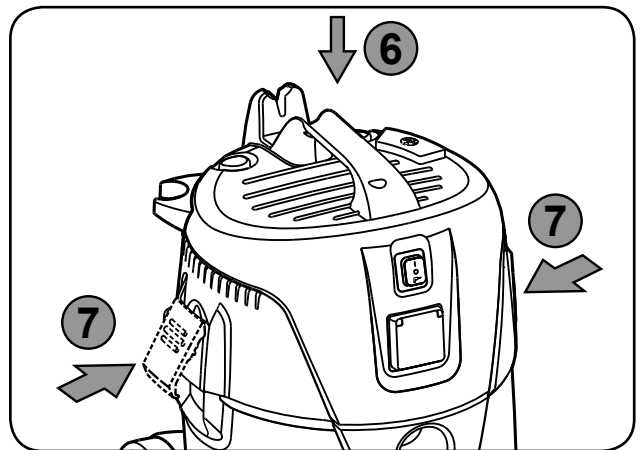
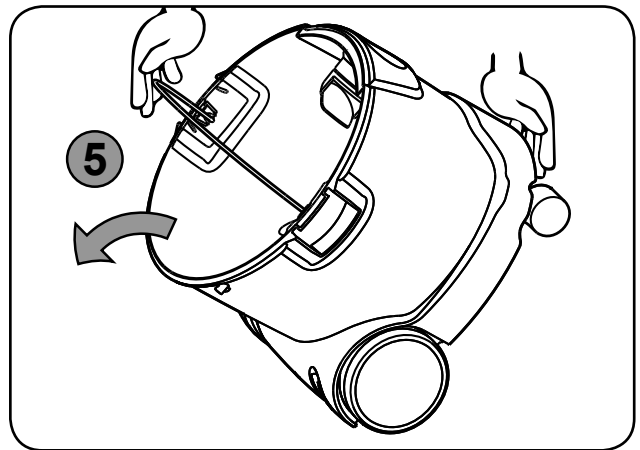
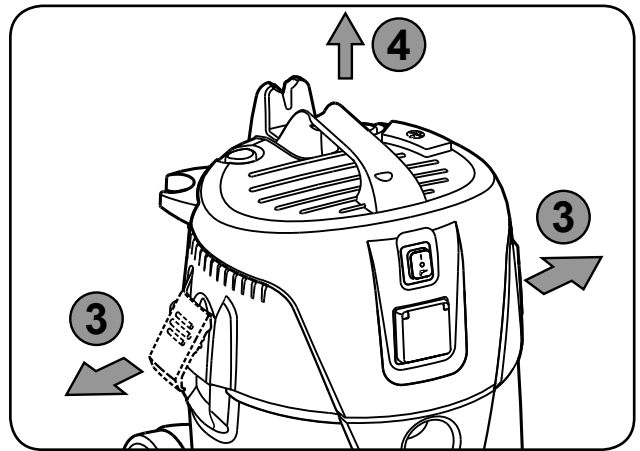
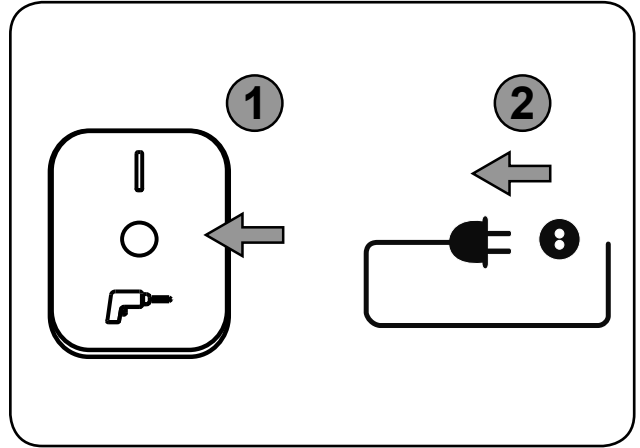

2B¹⁾

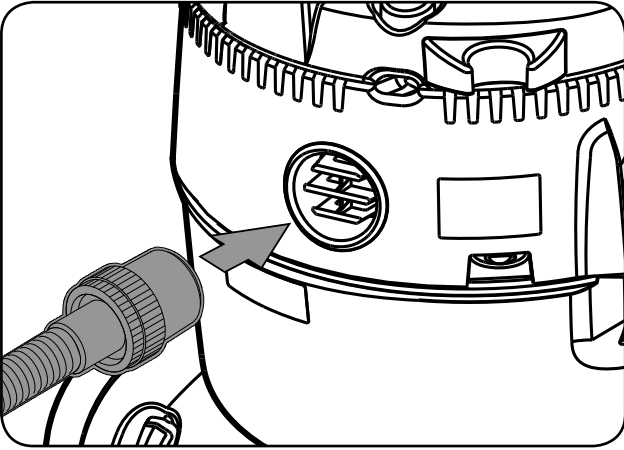

3B¹⁾

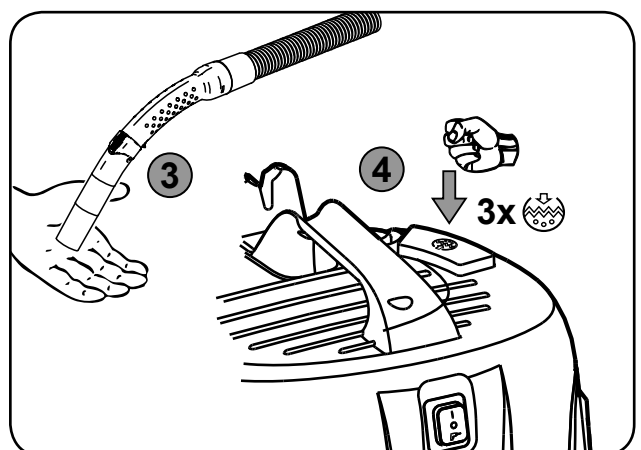
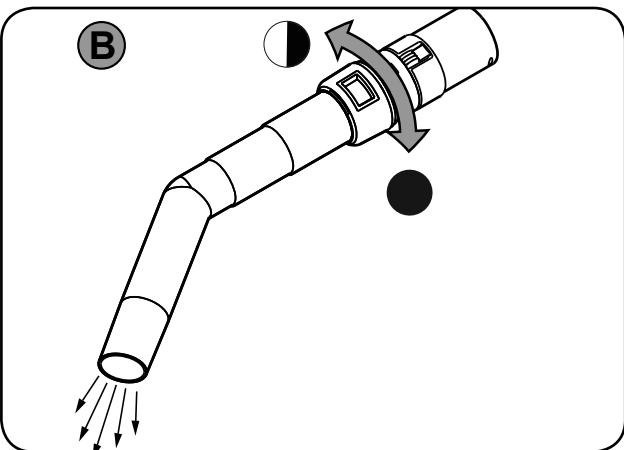
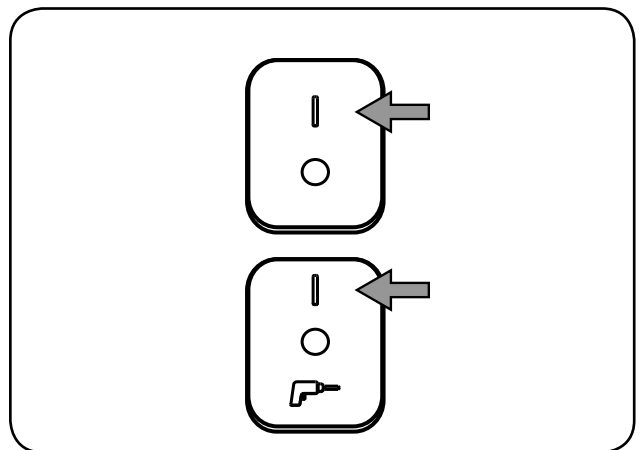
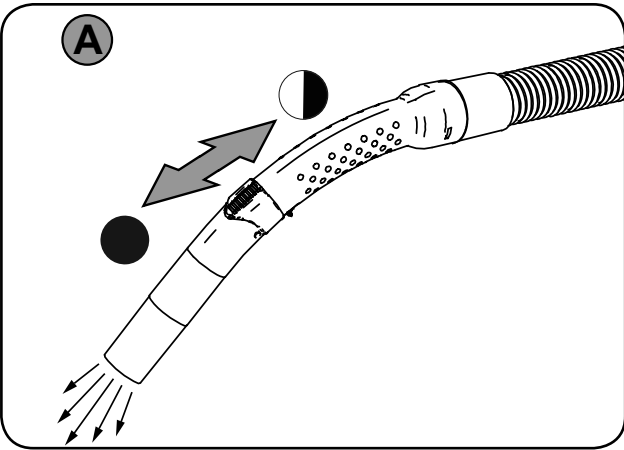
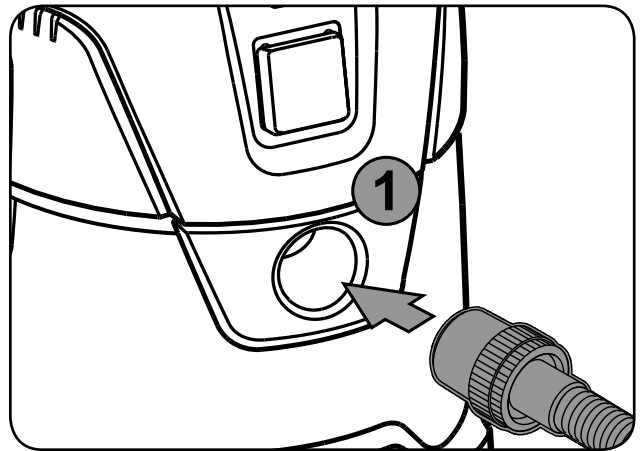
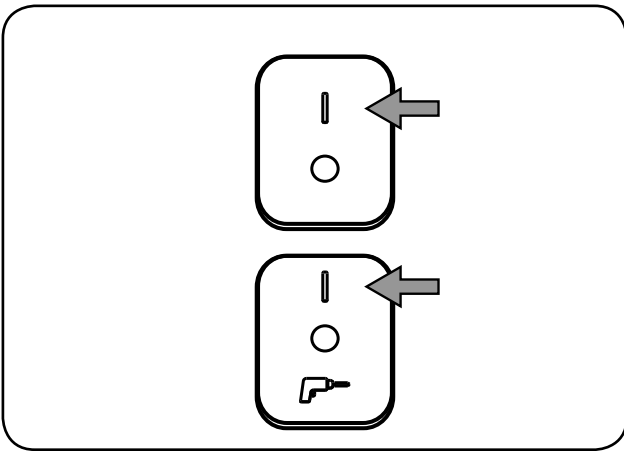
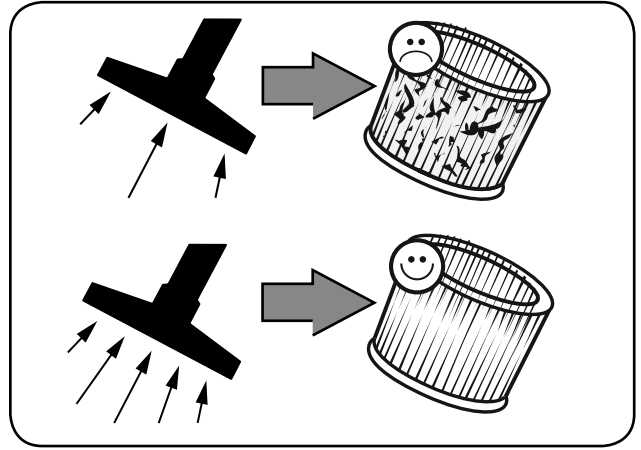

4B)

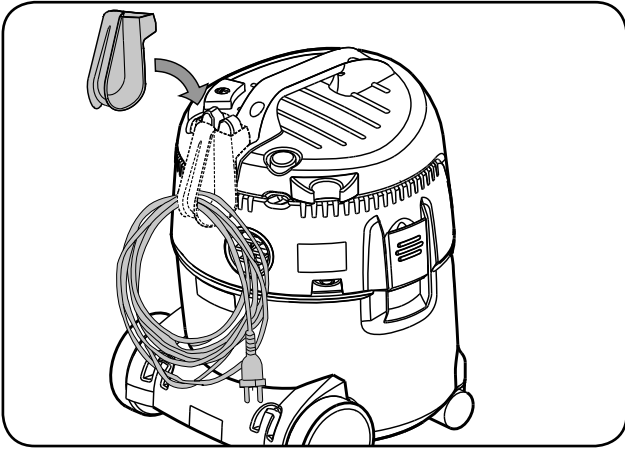

5B)

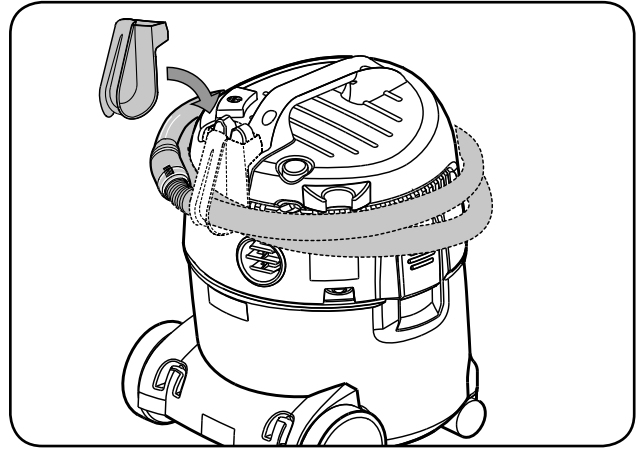

1C)

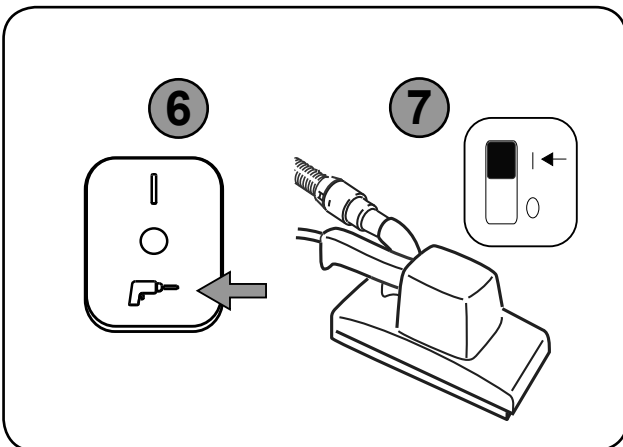
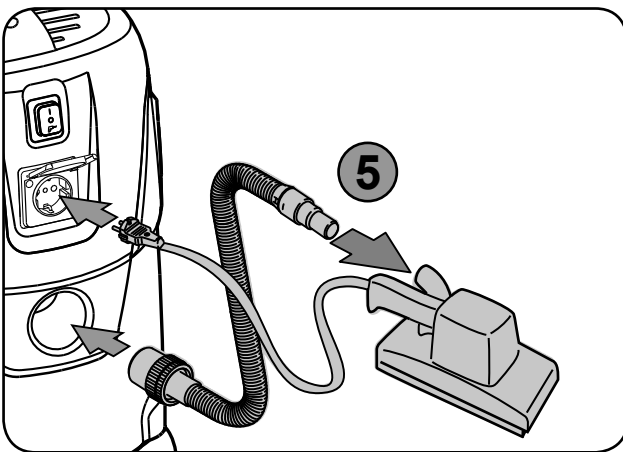
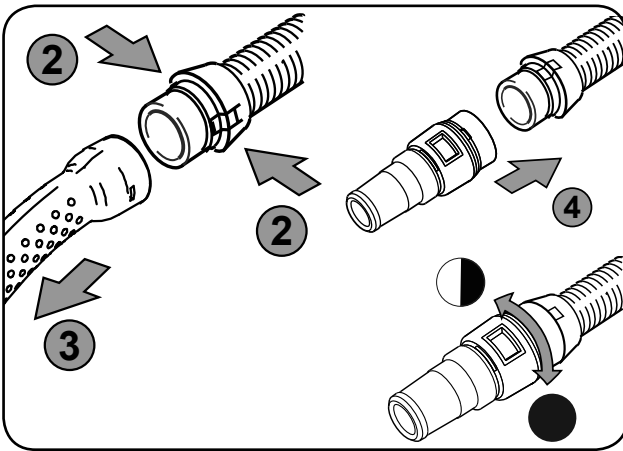
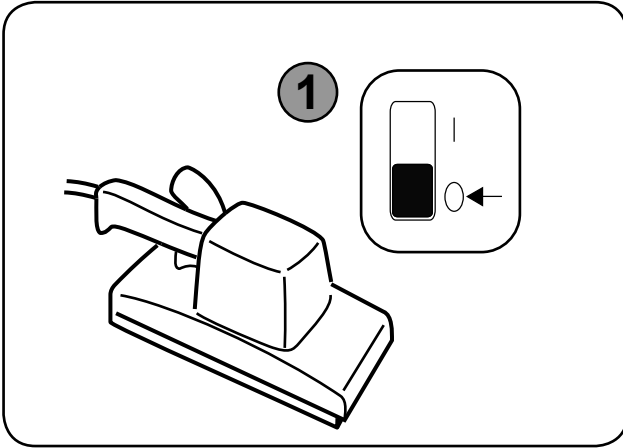

1D

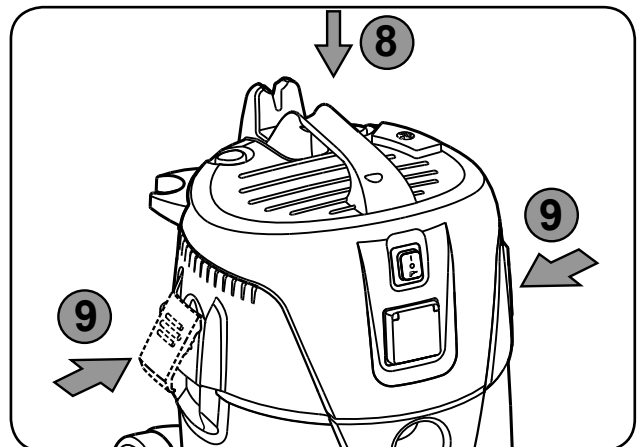
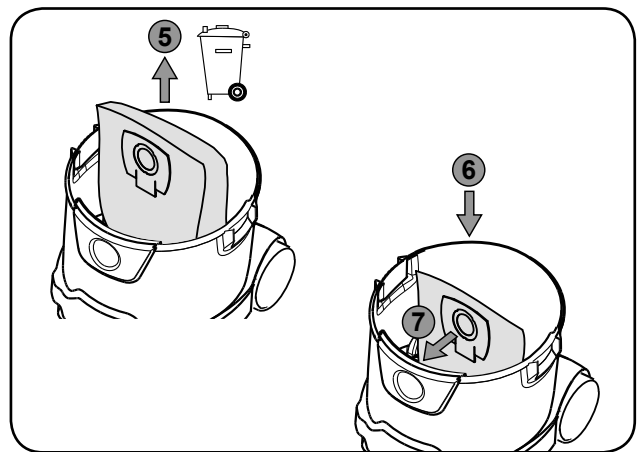
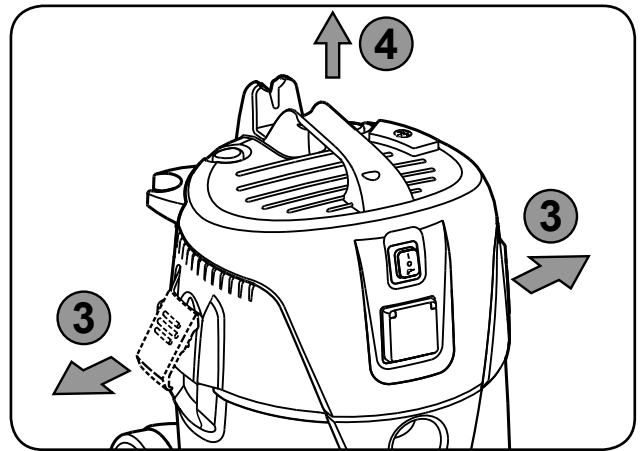
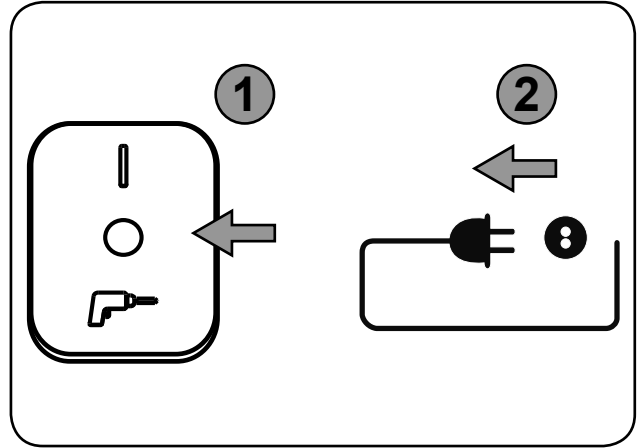

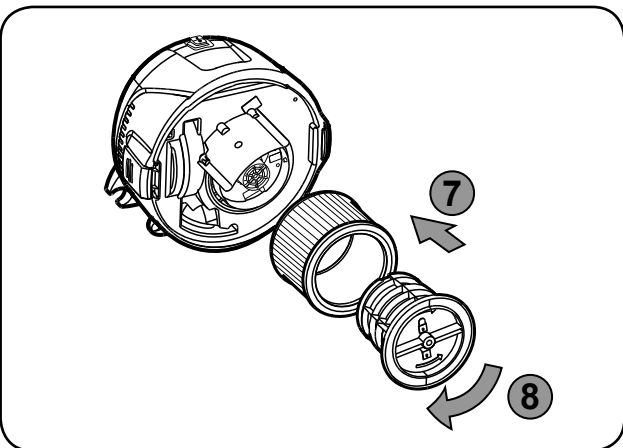
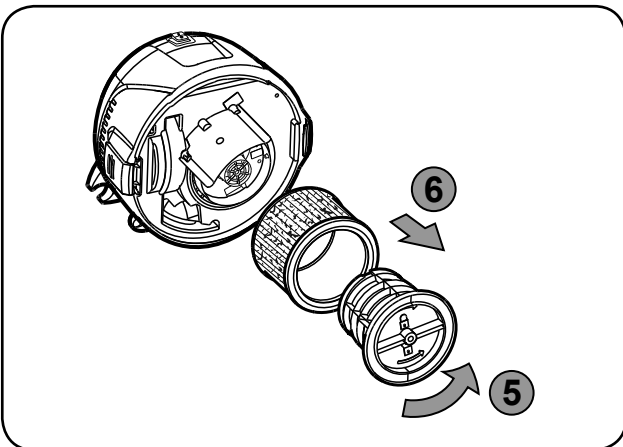
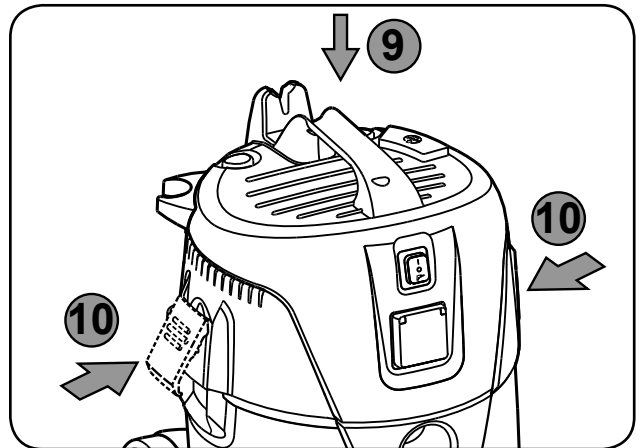
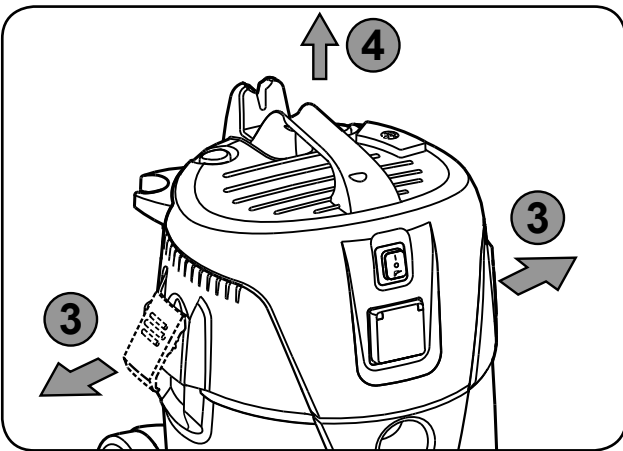
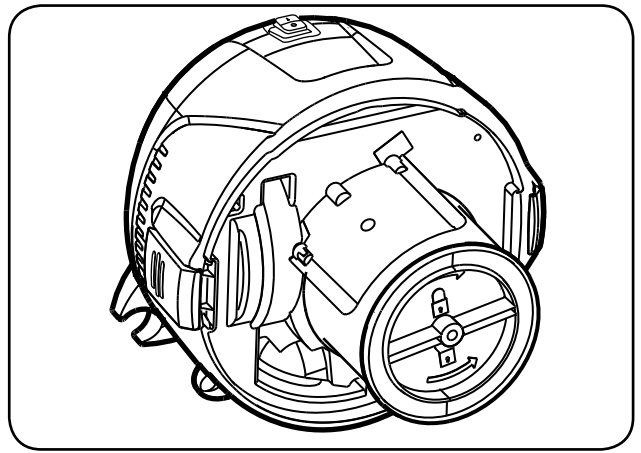
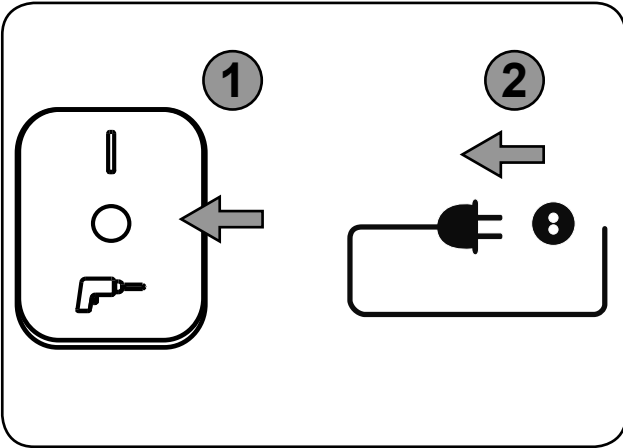

Quick reference guide

The pictorial quick reference guide

The pictorial quick reference guide is designed for helping you when starting up, operating and storing the unit. The guide are subdivided into 4 sections, which are represented by symbols:

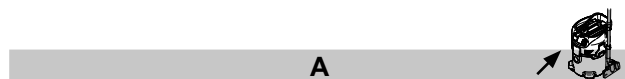

Before starting

- 1A - Unpack Accessories
- 2A - Filter Bag Installation
- 3A - Hose Insert
- 4A - Tube Fixed
- 5A - Accessories Placement



Control/Operation

- 1B - Emptying Container
- 2B - Blow Function
- 3B - Push&Clean
- 4B - Cable Storage
- 5B - Hose Storage



Connecting electrical appliances

- 1C - Power Tool



Replacement of:

- 1D - Filter Bag Replacement
- 2D - Filter Replacement

*) **Optional accessories / Option depending on model**

Contents

1	Important safety instructions	12
1.1	<i>Symbols used to mark instructions</i>	12
1.2	<i>Instructions for use</i>	12
1.3	<i>Purpose and intended use</i>	12
1.4	<i>Electrical connection</i>	12
1.5	<i>Extension lead</i>	12
1.6	<i>Guarantee</i>	12
1.7	<i>Tests and approvals</i>	12
1.8	<i>Important warnings</i>	13
1.9	<i>Double-insulated appliances*</i>	13
2	Risks	14
2.1	<i>Electrical components</i>	14
2.2	<i>Picking up liquids</i>	14
2.3	<i>Hazardous materials</i>	14
2.4	<i>Spare parts and accessories</i>	15
2.5	<i>Emptying dirt tank</i>	15
2.6	<i>In explosive or inflammable atmosphere</i> ..	15
2.7	<i>Blower function</i>	15
3	Control / Operation	15
3.1	<i>Starting and operating of the machine</i>	15
3.2	<i>Auto-On/Off-Operation for power tools*</i> ..	15
3.3	<i>Before wet pick-up</i>	15
3.4	<i>Emptying after wet pick-up</i>	15
3.5	<i>Emptying after dry pick-up</i>	15
3.6	<i>Push&Clean</i>	16
4	After using the cleaner	16
4.1	<i>After use</i>	16
4.2	<i>Transport</i>	16
4.3	<i>Storage</i>	16
4.4	<i>Recycling the cleaner</i>	16
5	Maintenance	16
5.1	<i>Regular servicing and inspection</i>	16
5.2	<i>Maintenance</i>	16
6	Further information	17
6.1	<i>Specifications</i>	17
	<i>EU Declaration of conformity</i>	209

1 Important safety instructions



This document contains the safety information relevant for the appliance along with a quick reference guide. Before starting up your vacuum cleaner for the first time, this instruction manual must be read through carefully. Save the instructions for later use.

Attached to the unit:

107419115 Vacuum Cleaner Safety Instructions US include important instructions to fire, electric shock, or injury.

Further support

Further information on the appliance can be found on our web site at www.Nilfisk.com
For further queries, please contact the Nilfisk service representative responsible for your country. See reverse of this document.

1.1 Symbols used to mark instructions

DANGER



Danger that leads directly to serious or irreversible injuries, or even death.

WARNING



Danger that can lead to serious injuries or even death.

CAUTION



Danger that can lead to minor injuries and damage.

1.2 Instructions for use

The appliance must:

- only be used by persons, who have been instructed in its correct usage and explicitly commissioned with the task of operating it
- only be operated under supervision
- This appliance is not intended for use by persons (including children) with reduced physical, sensory or mental capabilities, or lack of experience and knowledge.
- Children shall be supervised to make sure that they do not play with the appliance.
- Do not use any unsafe work techniques.
- Never use the vacuum cleaner without a filter.
- Switch off the appliance and disconnect the mains plug in the following situations:
 - Prior to cleaning and servicing
 - Prior to replacing components
 - Prior to changing over the appliance
 - If foam develops or liquid emerges

Besides the operating instructions and the binding accident prevention regulations valid in the country of use, observe recognised regulations for safety and proper use.

1.3 Purpose and intended use

This vacuum cleaner is designed, developed and rigorously tested to function efficiently and safely when properly maintained and used in accordance with the following instructions.

This vacuum cleaner is to be used for commercial or for household use. Accidents due to misuse can only be prevented by those using the machine. **READ AND FOLLOW ALL SAFETY INSTRUCTIONS.**

This machine is suitable for picking up dry, non-flammable dust and liquids.

Any other use is considered as improper use. The manufacturer accepts no liability for any damage resulting from such use. The risk for such use is borne solely by the user. Proper use also includes proper operation, servicing and repairs as specified by the manufacturer.

1.4 Electrical connection

1. It is recommended that the vacuum cleaner should be connected via a residual current circuit breaker.
2. Arrange the electrical parts (sockets, plugs and couplings) and lay down the extension lead so that the protection class is maintained.
3. Connectors and couplings of power supply cords and extension leads must be watertight.

1.5 Extension lead

1. As an extension lead, only use the version specified by the manufacturer or one of a higher quality.
2. When using an extension lead, check the minimum cross-sections of the cable:

Cable length	Cross section	
	< 16 A	< 25 A
up to 20 m	1.5 mm ²	2.5 mm ²
20 to 50 m	2.5 mm ²	4.0 mm ²

1.6 Guarantee

Our general conditions of business are applicable with regard to the guarantee. Unauthorised modifications to the appliance, the use of incorrect brushes in addition to using the appliance in a way other than for the intended purpose exempt the manufacturer from any liability for the resulting damage.

1.7 Tests and approvals

Electrical tests must be performed in accordance with the provisions of safety regulations EN 62638.

These tests must be performed at regular intervals and after repairs or modifications.

The vacuum cleaner has been approved in accordance with IEC/EN 60335-2-69.

1.8 Important warnings

WARNING



- To reduce the risk of fire, electric shock, or injury, please read and follow all safety instructions and caution markings before use. This vacuum cleaner is designed to be safe when used for cleaning functions as specified. Should damage occur to electrical or mechanical parts, the cleaner and / or accessory should be repaired by a competent service station or the manufacturer before use in order to avoid further damage to the machine or physical injury to the user.
- Do not leave the machine when it is plugged in. Unplug from the socket when not in use and before maintenance.
- Do not use with damaged cord or plug. To unplug grasp the plug, not the cord. Do not handle plug or cleaner with wet hands. Turn off all controls before unplugging.
- Do not pull or carry by cord, use cord as a handle, close a door on cord, or pull cord around sharp edges or corners. Do not run cleaner over cord. Keep cord away from heated surfaces.
- Keep hair, loose clothing, fingers and all parts of the body away from openings and moving parts. Do not put any objects into openings or use with opening blocked. Keep openings free of dust, lint, hair, and anything else that could reduce the flow of air.
- This machine is not suitable for picking up hazardous dust.
- Do not use to pick up flammable or combustible liquids such as gasoline, or use in areas where they may be present.
- Do not pick up anything that is burning or smoking, such as cigarettes, matches or hot ashes.
- Use extra care when cleaning on stairs.
- Do not use unless filters are fitted.
- If the cleaner is not working properly or has been dropped, damaged, left outdoors, or dropped into water, return it to a service center or dealer.
- If foam or liquid escapes from the machine, switch off immediately.
- The vacuum cleaner may not be used as a water pump. The vacuum cleaner is intended for vacuuming air and water mixtures.
- Connect the vacuum cleaner to a properly

earthed mains supply. The socket outlet and the extension cable must have an operative protective conductor.

- Provide for good ventilation at the working place.
- Do not use the vacuum cleaner as a ladder or step ladder. The vacuum cleaner can tip over and become damaged. Danger of injury.

1.9 Double-insulated appliances*



CAUTION



- Use only as described in this manual and only with the manufacturer's recommended attachments.
- BEFORE YOU PLUG IN YOUR CLEANER, check the rating plate at the cleaner to see if the rated voltage agrees within 10% of the voltage available.
- This appliance is provided with double insulation. Use only identical replacement parts. See instructions for servicing double insulated appliances.

In a double-insulated appliance, two systems of insulation are provided instead of grounding. No grounding means is provided on a double-insulated appliance, nor should a mean for grounding be added to the appliance. Servicing a double-insulated appliance requires extreme care and knowledge of the system, and should be done only by qualified service personnel. Replacement parts for a double-insulated appliance must be identical to the parts they replace. A double insulated appliance is marked with the words "DOUBLE INSULATION" or "DOUBLE INSULATED." The symbol (square within a square) may also be used on the product.

The machine is equipped with a specially designed cord which if damaged, must be replaced by a cord of the same type. This is available at authorised service centres and dealers and must be installed by trained personnel.

1.9.1 Only applicable to UK.

Please read these essential instructions

These instructions have been prepared with safety and efficiency paramount.

The machine operator must be trained by a suitably qualified instructor and must understand these instructions for use, and be made aware of any relevant regulations and legislation in force at the time of use.

1.9.2 Electrical connections

CAUTION



DOUBLE-INSULATED MACHINES - IMPORTANT:

This 240 volt 50 Hz. machine are fitted with a 13 amp. 3 pin moulded plug. The plug is fitted with a 13 amp. detachable fuse. The correct replacement for the fuse is identified by marking or colour coding. Only fuses that are ASTA approved to BS 1362 should be fitted. Never use the plug without the fuse cover fitted. Replacement fuse covers are available at any electrical retail outlet.

If the available socket outlet is not suitable for the plug supplied, the plug must be cut off and an appropriate plug fitted. The plug thus cut off **MUST BE DESTROYED** for safety reasons before being disposed of.

Machines built for other voltages and frequencies are not normally supplied with a fitted plug. If it is necessary to fit a plug, the wires in this power supply cord are coloured in accordance with the following code:

1.9.3 Blue-neutral brown-live

TO CONNECT THE NEW PLUG:

If using a three-pin plug, do not make any connection to the terminal in the plug which is marked with the letter 'E' or by the safety earth symbol or coloured green or green & yellow.

The blue wire must be connected to the terminal in the plug which is marked with the letter 'N' or is coloured black or blue.

The brown wire which must be connected to the terminal in the plug which is marked with the letter 'L' or is coloured red or brown.

If the plug to be fitted does not conform to the above notation then consult a qualified electrician.

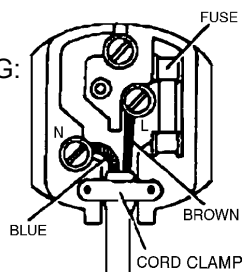

2 Risks

2.1 Electrical components

DANGER



The upper section of the vacuum cleaner contains live components. Contact with live components leads to serious or even fatal injuries.

- Never spray water on to the upper section of the vacuum cleaner.

DANGER



Electric shock due to faulty mains connecting lead. Touching a faulty mains connecting lead can result in serious or even fatal injuries.

- Do not damage the mains power lead (e.g. by driving over it, pulling or crushing it).
- Regularly check whether the power cord is damaged or shows signs of ageing.

- If the electric cable is damaged, it must be replaced by an authorized Nilfisk distributor or similar qualified person in order to avoid a hazard.
- In no circumstances should the power supply cord be wrapped around fingers or any part of the operators person.

CAUTION



Appliance socket.* The appliance socket is only designed for the purposes defined in the operating instructions. The connection of different appliances can result in damage.

- Prior to plugging in an appliance, always switch off the vacuum cleaner and the appliance that is to be connected.
- Read the operating instructions to the appliance to be connected and observe the safety notes contained in these.

CAUTION



Damage due to unsuitable mains voltage. The appliance can be damaged as a result of being connected to an unsuitable mains voltage.

- Ensure that the voltage shown on the rating plate corresponds to the voltage of the local mains power supply.

2.2 Picking up liquids

CAUTION



Picking up liquids. Do not pick up flammable liquids

- Before liquids are picked up, always remove the filter bag/wastebag and check that the float or the water level limit works properly.
- The use of a separate filter element or filter screen is recommended.
- If foam appears, stop work immediately and empty the tank.

2.3 Hazardous materials

WARNING



Hazardous materials. Vacuuming up hazardous materials can lead to serious or even fatal injuries

- The following materials must not be picked up by the vacuum cleaner:
- hazardous dust
- hot materials (burning cigarettes, hot ash, etc.)
- flammable, explosive, aggressive liquids (e.g. petrol, solvents, acids, alkalis, etc.)
- flammable, explosive dust (e.g. magnesium or aluminium dust, etc.)

2.4 Spare parts and accessories

CAUTION



Spare parts and accessories. The use of non-genuine spare parts and accessories can impair the safety of the appliance.

- Only use spare parts and accessories from Nilfisk.
- Use only the brushes supplied with the vacuum cleaner or specified in the operating manual.

2.5 Emptying dirt tank

CAUTION



Picking up environmentally hazardous materials.

Materials picked up can present a hazard to the environment.

- Dispose of the dirt in accordance with legal regulations.

2.6 In explosive or inflammable atmosphere

CAUTION



This machine is not suitable for use in explosive or inflammable atmospheres or where such atmospheres are likely to be produced by the presence of volatile liquid or inflammable gas or vapour.

2.7 Blower function.

CAUTION



The vacuum cleaner has a blower function. Do not blow the outgoing air randomly in enclosed areas. Use the blower function only with a clean hose. Dusts can be hazardous to one's health.

3 Control / Operation

3.1 Starting and operating of the machine

Check that the electrical switch is switched off (in position 0). Check that suitable filters are installed in the machine. Then connect the suction hose into the suction inlet at the machine by pushing the hose forward until it fits firmly in place at the inlet. Then connect the two tubes with the hose handle, twist the tubes in order to ensure that they are properly fitted. Attach suitable nozzle to the tube. Choose nozzle depending on what type of material that is to be picked-up. Connect the plug into a proper electrical outlet. Put the electrical switch into position 1 in order to start the motor.



Press 1 : Activate the machine
Press 0 : Stop the machine



Press 1 : Activate the machine
Press 0 : Stop the machine
Press  : Activate Auto-On/Off operation



Press 1 : Activate the machine - turn clockwise for speed control
Press 0 : Stop the machine
Press  : Activate Auto-On/Off operation - turn counter clockwise for speed control

3.2 Auto-On/Off-Operation for power tools*

A socket outlet with earthing contact is integrated in the vacuum cleaner. An external power tool can be connected there.

The vacuum cleaner can be switched on and off by the power tool connected. Dirt is picked up from the source of dust immediately.

To comply with regulations, only approved dust producing tools should be connected.

The maximum power consumption of the connected electrical appliance is stated in section "Specifications".

Before switching the switch to position  ensure that the tool connected to the appliance socket is switched off.

3.3 Before wet pick-up

CAUTION



The machine is equipped with a float system that shuts off the airflow through the machine when the maximum liquid level is reached. You will hear a noticeable change of the sound from the motor and notice that the suction power decreases. When this occurs, switch the machine off. Disconnect the machine from the socket. Never pick up liquid without the float body in place.

3.4 Emptying after wet pick-up

Before emptying the container, unplug the vacuum cleaner. Disconnect the hose from the inlet by pulling out the hose. Release the latch by pulling them outwards so that the motor top is released. Open up the motor top from container. Always empty and clean the container and the float system after picking-up liquids. Never pick up liquid without the float system and filter installed in the machine.

Empty by tilting the container backwards and pour the liquids into a floor drain or similar.

Put back the motor top to the container. Secure the motor top with the latches.

3.5 Emptying after dry pick-up

Remove the electrical plug from the socket before emptying after dry pick-up. Check the filters and dustbag regularly. Release the latch by pulling them outwards so that the motor top is released. Open up the motor top from container.

Cartridge filter: To clean the filter you can either shake, brush or wash it. Wait until it is dry before you reuse it.

Dustbag: check bag to ensure the fill factor. Replace dust bag if necessary. Remove the old bag. The new bag is fitted by passing the cardboard piece with the rubber membrane through the vacuum inlet. Make sure that the rubber membrane is passing past the heightening at the vacuum inlet.

After emptying: Close motor top to the container and secure the motor top with the latches. Never pick up dry material without cartridge filter and dustbag fitted in the machine. The suction efficiency of the vacuum cleaner depends on the size and quality of the filter and dust bag. Therefore - use only Original filter and dust bags.

3.6 Push&Clean

The machine is equipped with a semi automatic filter cleaning system. Push&Clean. The filter cleaning system must be actuated latest when the vacuuming performance is no longer sufficient. Regular use of the filter cleaning feature increases the tool life of the filter.

4 After using the cleaner

4.1 After use

Remove the plug from the socket when machine is not in use. Wind up the cord starting from the machine. The power cord can be wound up around the motor top or at the container. Some variants have special storage places for accessories.

4.2 Transport

- Before transporting the dirt tank, close all the locks.
- Do not tilt the cleaner if there is liquid in the dirt tank.
- Do not use a crane hook to lift the cleaner.

4.3 Storage

- Store the appliance in a dry place, protected from rain and frost.
- The machine shall be stored indoors only.

4.4 Recycling the cleaner

Make the old cleaner unusable.

1. Unplug the cleaner.
2. Cut the power cord.
3. Do not discard of electrical appliances with household waste.



Equipment marked with the crossed-out wheeled bin symbol indicates that used electrical and electronic equipment should not be discarded together with unseparated household waste. To avoid negative effects on human health and the environment the equipment must be

collected separately at the designated collection points. Users of electrical and electronic household equipment must use the municipal collection schemes. Please note that commercially used electrical and electronic equipment, shall not be disposed of via municipal collection schemes. We will be pleased to inform you about suitable disposal options.

5 Maintenance

5.1 Regular servicing and inspection

Regular servicing and inspection of your machine must be carried out by suitably qualified personnel in accordance with relevant legislation and regulations. In particular, electrical tests for earth continuity, insulation resistance, and condition of the flexible cord should be checked frequently. In the event of any defect, the machine **MUST** be withdrawn from service, completely checked and repaired by an authorized service technician.

5.2 Maintenance

Remove the plug from the socket before performing maintenance. Before using the machine make sure that the frequency and voltage shown on the rating plate correspond with the mains voltage.

The cleaner is designed for continuous heavy work. Depending on the number of running hours – the dust filter should be renewed. Keep the vacuum cleaner clean with a dry cloth, and a small amount of spray polish.

For details of after sales service contact your dealer or Nilfisk service representative responsible for your country. See reverse of this document.

6 Further information

6.1 Specifications

AERO 21, AERO 21 INOX									
		EU		GB		CH		US	JP
		21-01	21-21	21-01	21-01	21-01	21-21	21-01	21-01
Possible voltage	V	220-240V	220-240V	230V	110V	230V	230V	120V	100V
Power P _{iec}	W	1000	1000	1000	1000	1000	1000	1000	1200
Connected load for appliance socket	W	-	2600 / 1300*	-	-	-	1300	-	-
Mains frequency	Hz	50/60	50/60	50/60	50/60	50/60	50/60	50/60	50/60
Fuse	A	16 / 10*	16 / 10*	13	16	10	10	15	15
Protection grade (moist, dust)		IP24							
Protection class (electrical)		II □	I	II □	II □	II □	I	II □	II □
Airflow	litres/min m ³ /h	3600 216							
Vacuum	kPa	21							23
Sound pressure level 1 m, EN 60704-1	dB(A)+/-2	72							73
Working sound level	dB(A)+/-2	64							65
Vibration ISO 5349	m/s ² +/- 1	<1,5							
Weight	kg	7,5 / 8,5 (INOX)							
* DK									

Specifications and details are subject to change without prior notice.

Declaration of Conformity

Prohlášení o shodě
 Konformitätserklärung
 Overensstemmelseserklæring
 Declaración de conformidad
 Vastavusdeklaratsioon
 Déclaration de conformité
 Vaatimustenmukaisuusvakuutus

Декларация за съответствие
 Δήλωση συμμόρφωσης
 Megfelelősségi nyilatkozat
 Izjava o skladnosti
 Dichiarazione di conformità
 Atitikties deklaracija
 Atbilstības deklarācija
 Samsvarserklæring
 Conformiteitsverklaring

Declaração de conformidade
 Deklaracija zgodności
 Declaratie de conformitate
 Декларация о соответствии
 Försäkran om överensstämmelse
 Vyhlášení o zhode
 Izjava o skladnosti
 Uygunluk beyanı

Manufacturer / Výrobce / Hersteller / Fabrikant /
 Fabricante / Κατασκευαστής / Gyártó / Proizvođač /
 Fabbricante / Gamintojas / Ražotājs / Producers /
 Fabrikant / Fabricante / Producent / Producător /
 производитель / Tillverkaren / Výrobca / Proizvajalec /
 Üretici firma:

**Nilfisk A/S, Kornmarksvej 1
 DK-2605 Broendby, DENMARK**

Product / Produkt / Producto, Toode, Produit, Tuote /
 Продукт / Προϊόν / Termék / Proizvod / Prodotto /
 Produktas / Produkts / Artikel / Produtos / Prods /
 Izdelek / Ürün

Aero 21*

Description / Popis / Beschreibung / Beskrivelse /
 Descripción / Kirjeldus / La description / Kuvaus /
 Описание / Περιγραφή / Leirás / Opis / Descrizione /
 Aprašymas / Apraksts / Beschrijving / Descrição /
 Descriere / Beskrivning / Popis / Açıklama

**VAC - Commercial - Wet/Dry
 220-240V 50-60Hz, IPX4**

EN

**We, Nilfisk hereby declare under our sole
 responsibility, that the above-mentioned
 product(s) is/are in conformity with the
 following directives and standards.**

LT

Mes, „Nilfisk“, prisiimdami visišką
 atsakomybę pareiškiame, kad pirmiau
 minėtas produktas (-ai) atitinka šias
 direktyvas ir standartus

CS

My, Nilfisk prohlašujeme na svou výlučnou
 odpovědnost, že výše uvedený výrobek je ve
 shodě s následujícími směrnici a normami.

LV

Mēs, Nilfisk, ar pilnu atbildību apliecinām, ka
 iepriekšminētais produkts atbilst šādām
 direktīvām un standartiem

DE

Wir, Nilfisk erklären in alleiniger
 Verantwortung, dass das oben genannte
 Produkt den folgenden Richtlinien und
 Normen entspricht.

NO

Vi, Nilfisk erklærer herved under eget ansvar,
 at det ovennevnte produktet er i samsvar
 med følgende direktiver og standarder

DA

Vi, Nilfisk erklærer hermed under eget ansvar
 at ovennævnte produkt(er) er i
 overensstemmelse med følgende direktiver og
 standarder.

NL

We verklaren Nilfisk hierbij op eigen
 verantwoordelijkheid, dat het
 bovengenoemde product voldoet aan de
 volgende richtlijnen en normen

ES

Nosotros, Nilfisk declaramos bajo nuestra
 única responsabilidad que el producto antes
 mencionado está en conformidad con las
 siguientes directivas y normas

PT

Nós, a Nilfisk declaramos, sob nossa exclusiva
 responsabilidade, que o produto acima
 mencionado está em conformidade com as
 diretrizes e normas a seguir

ET

Meie, Nilfisk Käesolevaga kinnitame ja
 kanname ainuisikulist vastutust, et eespool

PL

My, Nilfisk Niniejszym oświadczamy z pełną
 odpowiedzialnością, że wyżej wymieniony



nimetatud toode on kooskõlas järgmiste direktiivide ja
Nilfisk déclare sous notre seule responsabilité que le produit mentionné ci-dessus est conforme aux directives et normes suivantes.



produkt jest zgodny z następującymi dyrektywami i normami.
Noi, Nilfisk Prin prezenta declarăm pe propria răspundere, că produsul mai sus menționat este în conformitate cu următoarele standarde și directive



Me, Nilfisk täten vakuutamme omalla vastuulla, että edellä mainittu tuote on yhdenmukainen seuraavien direktiivien ja standardien mukaisesti



Мы, Nilfisk настоящим заявляем под нашу полную ответственность, что вышеперечисленные продукция соответствует следующими директивам и стандартам.



Ние, Nilfisk С настоящото декларираме на своя лична отговорност, че посочените по-горе продуктът е в съответствие със следните директиви и стандарти.



Vi Nilfisk förklarar härmed under eget ansvar att ovan nämnda produkt överensstämmer med följande direktiv och normer.



Εμείς, Nilfisk δηλώνουμε με αποκλειστική μας ευθύνη, ότι το προαναφερόμενο προϊόν συμμορφώνεται με τις ακόλουθες οδηγίες και πρότυπα.



My, Nilfisk prehlasujeme na svoju výlučnú zodpovednosť, že vyššie uvedený výrobok je v zhode s nasledujúcimi smernicami a normami.



Mi, Nilfisk Kijelentjük, egyedüli felelősséggel, hogy a fent említett termék megfelel az alábbi irányelveknek és szabványoknak



Mi, Nilfisk izjavljamo s polno odgovornostjo, da je zgoraj omenjeni izdelek v skladu z naslednjimi smernicami in standardi.



Mi, Nilfisk Izjavljujemo pod punom odgovornošću, da gore navedeni proizvod u skladu sa sljedećim direktivama i standardima.



Nilfisk, burada yer alan tüm sorumluluklarımıza göre, yukarıda belirtilen ürünün aşağıdaki direktifler ve standartlara uygun olduğunu beyan ederiz.



Noi, Nilfisk dichiara sotto la propria responsabilità, che il prodotto di cui sopra è conforme alle seguenti direttive e norme.

2006/42/EC

EN 60335-1:2012+A11:2014+A13:2017
EN 60335-2-69:2012

2014/30/EU

EN 55014-1:2017+A11:2020
EN 55014-2:2015
EN 61000-3-2:2019
EN 61000-3-3:2013+A1:2019

2011/65/EU

EN 63000:2018

Authorized signatory:

Pierre Mikaelsson, Executive Vice President, Global Products & Services, Nilfisk NLT

March 12, 2021



UK Declaration of Conformity

We,
Nilfisk Ltd
Nilfisk House, Bowerbank Way Gilwilly Industrial Estate
Penrith Cumbria
CA11 9BQ UK

Hereby declare under our sole responsibility that the

Products: VAC - Commercial - Wet/Dry
Description: 220-240V 50-60Hz, IPX4
Type: Aero 21*, 26*, 31*, VL200

Are in compliance with the following standards:

EN 60335-1:2012+A11:2014+A13:2017
EN 60335-2-69:2012
EN 55014-1:2017+A11:2020
EN 55014-2:2015
EN 61000-3-2:2019
EN 61000-3-3:2013+A1:2019
EN 63000:2018

Following the provisions of:

Supply of Machinery (Safety) Regulations 2008/1597
Electromagnetic Compatibility Regulations 2016/1091
The Restriction of the Use of Certain Hazardous Substances in Electrical and Electronic Equipment
Regulations 2012/3032

Penrith, 20-1-2021

A handwritten signature in black ink, appearing to read 'Stewart Dennett', written over a horizontal line.

Stewart Dennett
GM/MD



HEAD QUARTER

DENMARK

Nilfisk A/S
Kornmarksvej 1
DK-2605 Broendby
Tel.: (+45) 4323 8100
www.nilfisk.com

SALES COMPANIES

ARGENTINA

Nilfisk Argentina
Herrera 1855 Piso 4° B Ofic 405
Ciudad de Buenos Aires
Tel.: (+54) 11 6091 1576
www.nilfisk.com.ar

AUSTRALIA

Nilfisk Pty Ltd
Unit 1/13 Bessemer Street
Blacktown NSW 2148
Tel.: (+61) 2 98348100
www.nilfisk.com.au

AUSTRIA

Nilfisk GmbH
Metzgerstrasse 68
5101 Bergheim bei Salzburg
Tel.: (+43) 662 456 400 90
www.nilfisk.at

BELGIUM

Nilfisk n.v.s.a.
Riverside Business Park
Boulevard Internationalelaan 55
Bâtiment C3/C4 Gebouw
Bruxelles 1070
Tel.: (+32) 24 67 60 50
www.nilfisk.be

BRAZIL

Nilfisk do Brasil
Av. Eng. Luis Carlos Berrini, 550
40 Andar, Sala 03
SP - 04571-000 Sao Paulo
Tel.: (+11) 3959-0300 / 3945-4744
www.nilfisk.com.br

CANADA

Nilfisk Canada Company
240 Superior Boulevard
Mississauga, Ontario L5T 2L2
Tel.: (+1) 800-668-8400
www.nilfisk.ca

CHILE

Nilfisk S.A. (Comercial KCS Ltda)
Salar de Llamara 822
8320000 Santiago
Tel.: (+56) 2684 5000
www.nilfisk.cl

CHINA

Nilfisk
4189 Yindu Road
Xinzhuang Industrial Park
201108 Shanghai
Tel.: (+86) 21 3323 2000
www.nilfisk.cn

CZECH REPUBLIC

Nilfisk s.r.o.
VGP Park Horní Počernice
Do Čertous 1/2658
193 00 Praha 9
Tel.: (+420) 244 090 912
www.nilfisk.cz

DENMARK

Nilfisk Danmark A/S
Industrivej 1
Hadsund, DK-9560
Tel.: 72 18 21 20
www.nilfisk.dk

FINLAND

Nilfisk Oy Ab
Koskelontie 23 E
02920 Espoo
Tel.: (+358) 207 890 600
www.nilfisk.fi

FRANCE

Nilfisk SAS
26 Avenue de la Baltique
Villebon sur Yvette
91978 Courtabouef Cedex
Tel.: (+33) 169 59 87 00
www.nilfisk.fr

GERMANY

Nilfisk GmbH
Guido-Oberdorfer-Straße 2-10
89287 Bellenberg
Tel.: (+49) (0)7306/72-444
www.nilfisk.de

GREECE

Nilfisk A.E.
Αναπαύσεως 29
Κορωπί T.K. 194 00
Tel.: (30) 210 9119 600
www.nilfisk.gr

HOLLAND

Nilfisk B.V.
Versterkerstraat 5
1322 AN Almere
Tel.: (+31) 036 5460760
www.nilfisk.nl

HONG KONG

Nilfisk Ltd.
2001 HK Worsted Mills
Industrial Building
31-39, Wo Tong Tsui St.
Kwai Chung, N.T.
Tel.: (+852) 2427 5951
www.nilfisk.com

HUNGARY

Nilfisk Kft.
II. Rákóczi Ferenc út 10
2310 Szigetszentmiklós-Lakihegy
Tel.: (+36) 24 475 550
www.nilfisk.hu

INDIA

Nilfisk India Limited
Pramukh Plaza, 'B' Wing, 4th floor,
Unit No. 403
Cardinal Gracious Road, Chakala
Andheri (East) Mumbai 400 099
Tel.: (+91) 22 6118 8188
www.nilfisk.in

IRELAND

Nilfisk
1 Stokes Place
St. Stephen's Green
Dublin 2
Tel.: (+35) 3 12 94 38 38
www.nilfisk.ie

ITALY

Nilfisk SpA
Strada Comunale della Braglia, 18
26862 Guardamiglio (LO)
Tel.: (+39) (0) 377 414021
www.nilfisk.it

JAPAN

Nilfisk Inc.
1-6-6 Kita-shinyokohama, Kouhoku-ku
Yokohama, 223-0059
Tel.: (+81) 45548 2571
www.nilfisk.com

MALAYSIA

Nilfisk Sdn Bhd
Sd 33, Jalan KIP 10
Taman Perindustrian KIP
Sri Damansara
52200 Kuala Lumpur
Tel.: (60) 3603 627 43 120
www.nilfisk.com

MEXICO

Nilfisk de Mexico, S. de R.L. de C.V.
Pirineos #515 Int.
60-70 Microparque
Industrial WSantiago
76120 Queretaro
Tel.: (+52) (442) 427 77 00
www.nilfisk.com

NEW ZEALAND

Nilfisk Limited
Suite F, Building E
42 Tawa Drive
0632 Albany Auckland
Tel.: (+64) 9 414 1996
Website: www.nilfisk.com

NORWAY

Nilfisk AS
Bjørnerudveien 24
1266 Oslo
Tel.: (+47) 22 75 17 80
www.nilfisk.no

PERU

Nilfisk S.A.C.
Calle Boulevard 162, Of. 703, Lima
33- Perú
Lima
Tel.: (511) 435-6840
www.nilfisk.com

POLAND

Nilfisk Sp. Z.O.O.
Millenium Logistic Park
ul. 3 Maja 8, Bud. B4
05-800 Pruszków
Tel.: (+48) 22 738 3750
www.nilfisk.pl

PORTUGAL

Nilfisk Lda.
Sintra Business Park
Zona Industrial Da Abrunheira
Edifício 1, 1° A
P2710-089 Sintra
Tel.: (+351) 21 911 2670
www.nilfisk.pt

RUSSIA

Nilfisk LLC
Vyatskaya str. 27, bld. 7/1st
127015 Moscow
Tel.: (+7) 495 783 9602
www.nilfisk.ru

SINGAPORE

Den-Sin
22 Tuas Avenue 2
639453 Singapore
Tel.: (+65) 6268 1006
www.densin.com

SLOVAKIA

Nilfisk s.r.o.
Bancikovej 1/A
SK-821 03 Bratislava
Tel.: (+421) 910 222 928
www.nilfisk.sk

SOUTH AFRICA

Nilfisk (Pty) Ltd
Kimbult Office Park
9 Zeiss Road
Laser Park
Honeydew
Johannesburg
Tel.: +27118014600
www.nilfisk.co.za

SOUTH KOREA

Nilfisk Korea
#204 2F Seoulsup Kolon Digital
Tower
25 Seongsuil-ro 4-gil, Seongdong-gu
Seoul.
Tel.: (+ 82) 2 3474 4141
www.nilfisk.co.kr

SPAIN

Nilfisk S.A.
Torre d'Ara,
Passeig del Rengle, 5 Plta. 10ª
08302 Mataró
Tel.: (34) 93 741 2400
www.nilfisk.es

SWEDEN

Nilfisk AB
Taljegårdsgatan 4
431 53 Mölndal
Tel.: (+46) 31 706 73 00
www.nilfisk.se

SWITZERLAND

Nilfisk AG
Ringstrasse 19
Kircheberg/Industri Stelz
9500 Wil
Tel.: (+41) 71 92 38 444
www.nilfisk.ch

TAIWAN

Nilfisk Ltd
Taiwan Branch (H.K.)
No. 5, Wan Fang Road
Taipei
Tel.: (+88) 6227 00 22 68
www.nilfisk.tw

THAILAND

Nilfisk Co. Ltd.
89 Soi Chokechai-Ruammitr
Viphavadee-Rangsit Road
Ladyao, Jatuchak, Bangkok 10900
Tel.: (+66) 2275 5630
www.nilfisk.co.th

TURKEY

Nilfisk A.S.
Serifali Mh. Bayraktar Bulv. Sehiz
Sk. No:7
Ümraniye, 34775 Istanbul
Tel.: +90 216 466 94 94
www.nilfisk.com.tr

UNITED ARAB EMIRATES

Nilfisk Middle East Branch
SAIF-Zone
P.O. Box 122298
Sharjah
Tel.: (+971) (0) 655-78813
www.nilfisk.com

UNITED KINGDOM

Nilfisk Ltd.
Nilfisk House, Bowerbank Way
Gilwilly Industrial Estate, Penrith
Cumbria CA11 9BQ
Tel.: (+44) (0) 1768 868995
www.nilfisk.co.uk

UNITED STATES

Nilfisk, Inc.
9435 Winnetka Ave N,
Brooklyn Park
MN- 55445
www.nilfisk.com

VIETNAM

Nilfisk Vietnam
No. 51 Doc Ngu Str.
P. Vinh Phúc, Q.Ba Dinh
Hanoi
Tel.: (+84) 761 5642
www.nilfisk.com

